

1 in
Test Square
(test your printer)

A central rectangular area enclosed by a dashed line, with small scissors icons at each of the four corners. Inside this area, the text reads:

Aida Top
Sew Liberated
Stop by our little corner of cyberspace,
SewLiberated.com, for more patterns!
© 2016 Sew Liberated

At the bottom of this area is the logo for Sew Liberated, which features the word "SEW" in a bold, sans-serif font above the word "LIBERATED" in a cursive script. A stylized needle and thread icon is positioned to the left of the word "SEW".

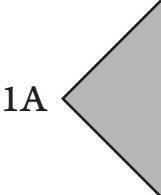
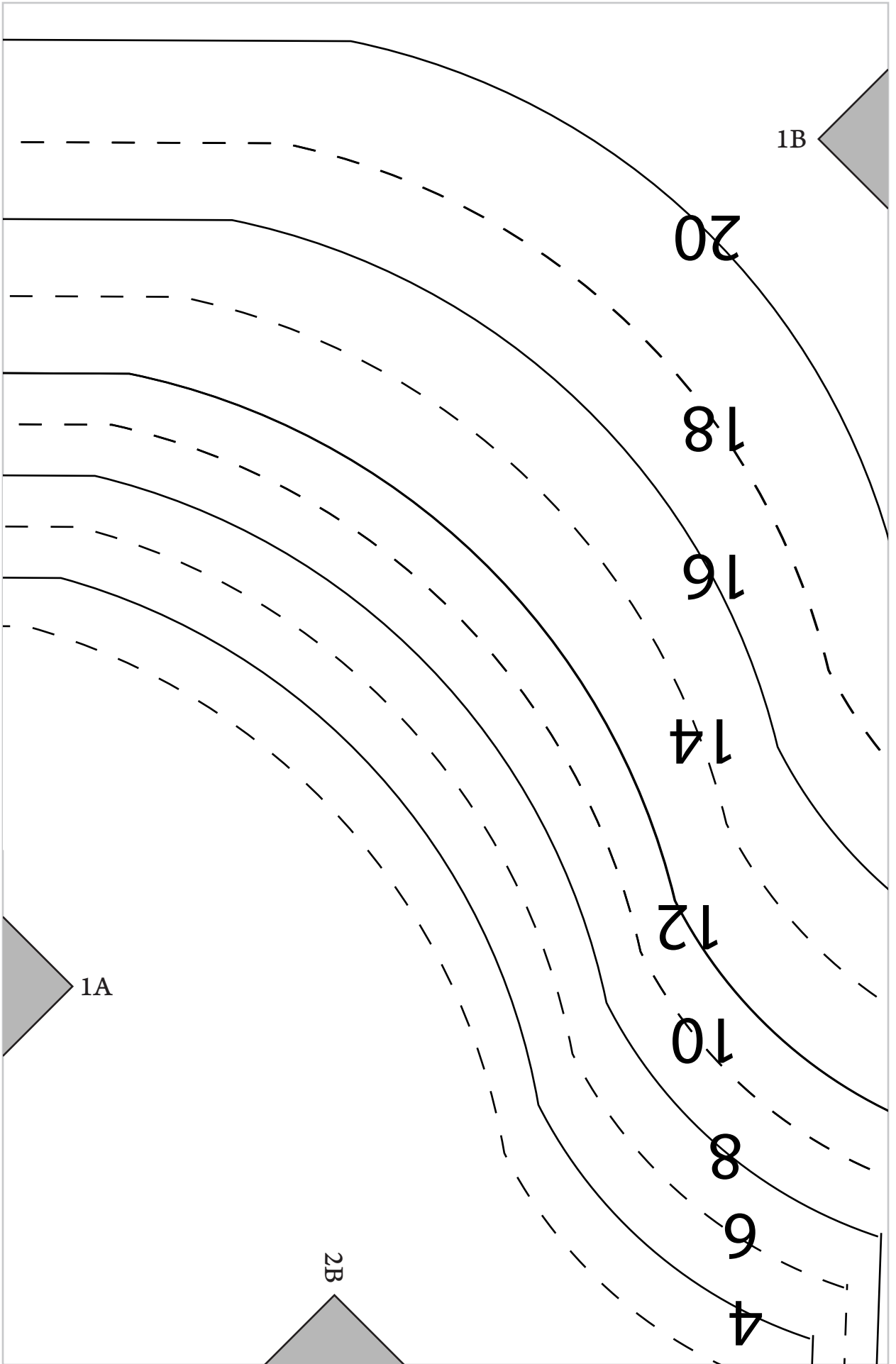

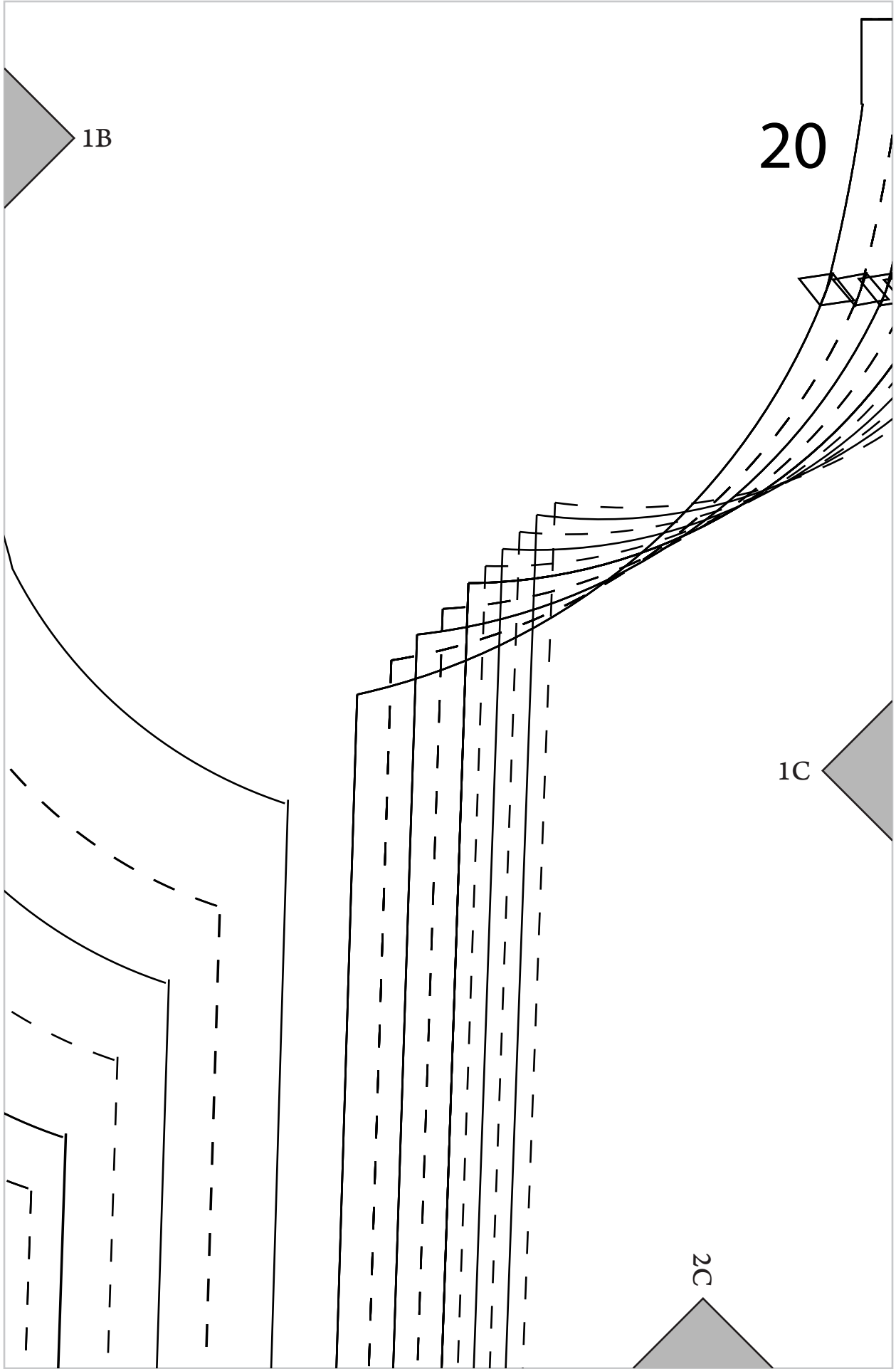

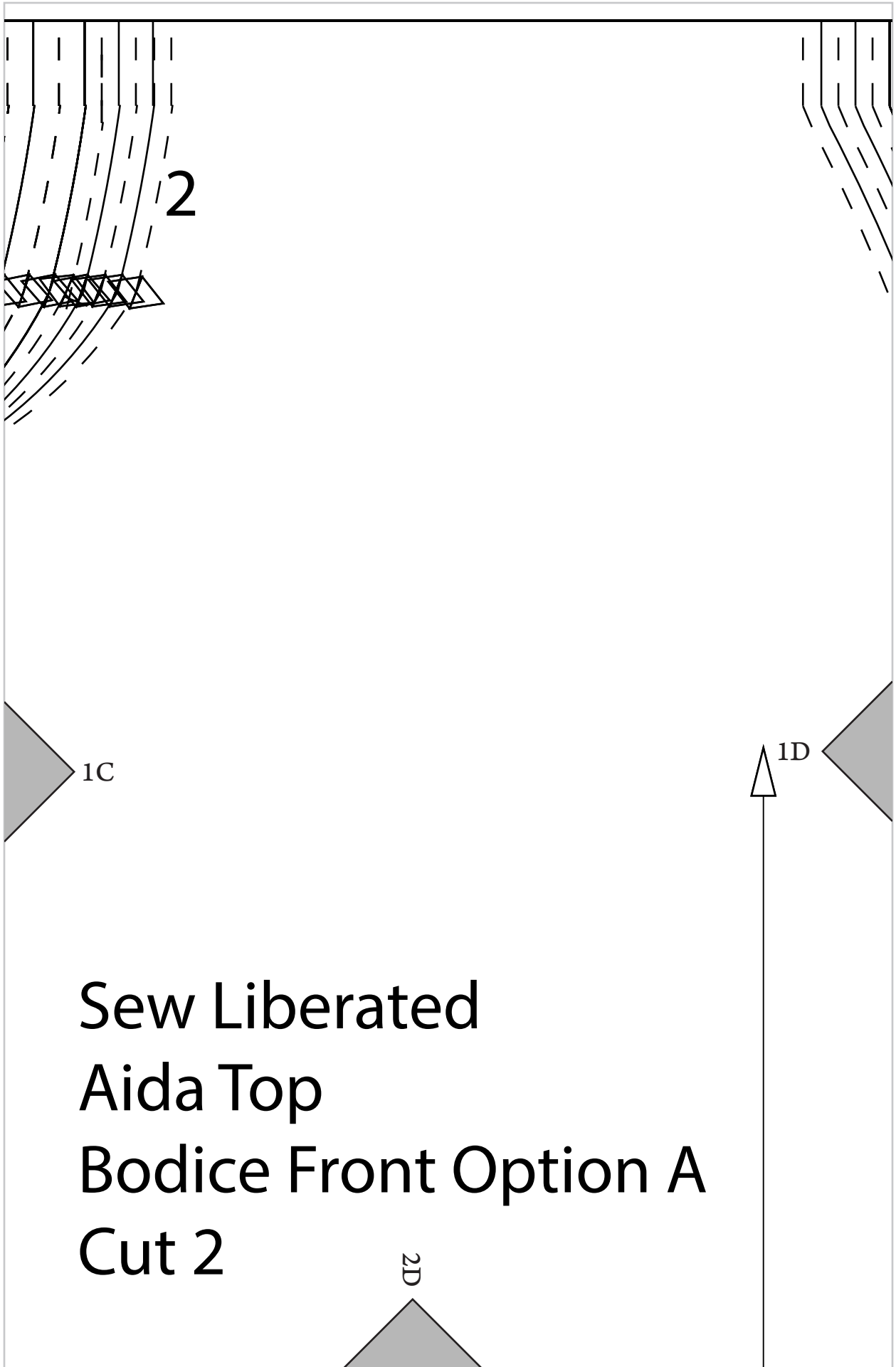

Sew Liberated
Aida Top
Bodice Front Option A
Cut 2

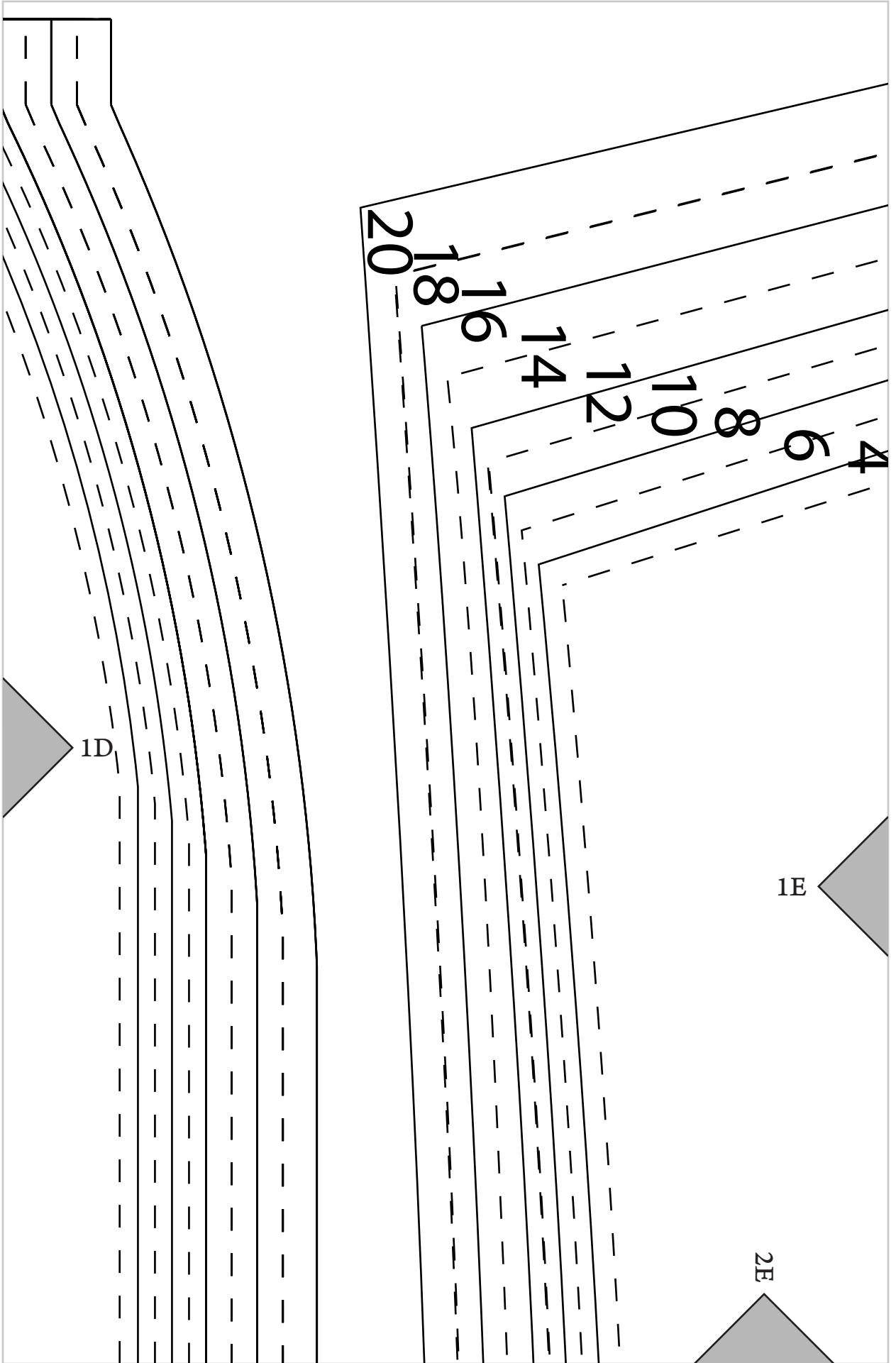

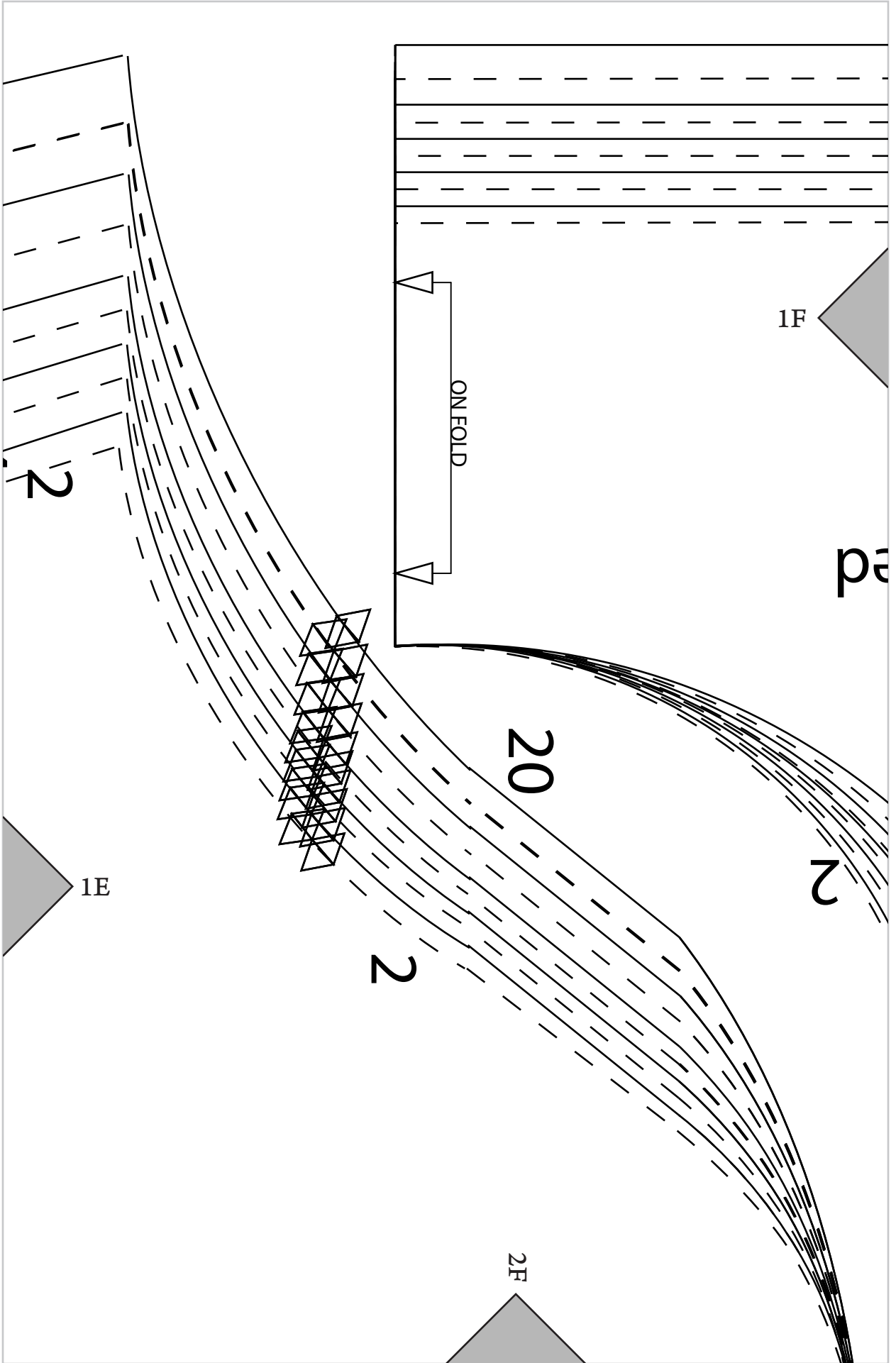

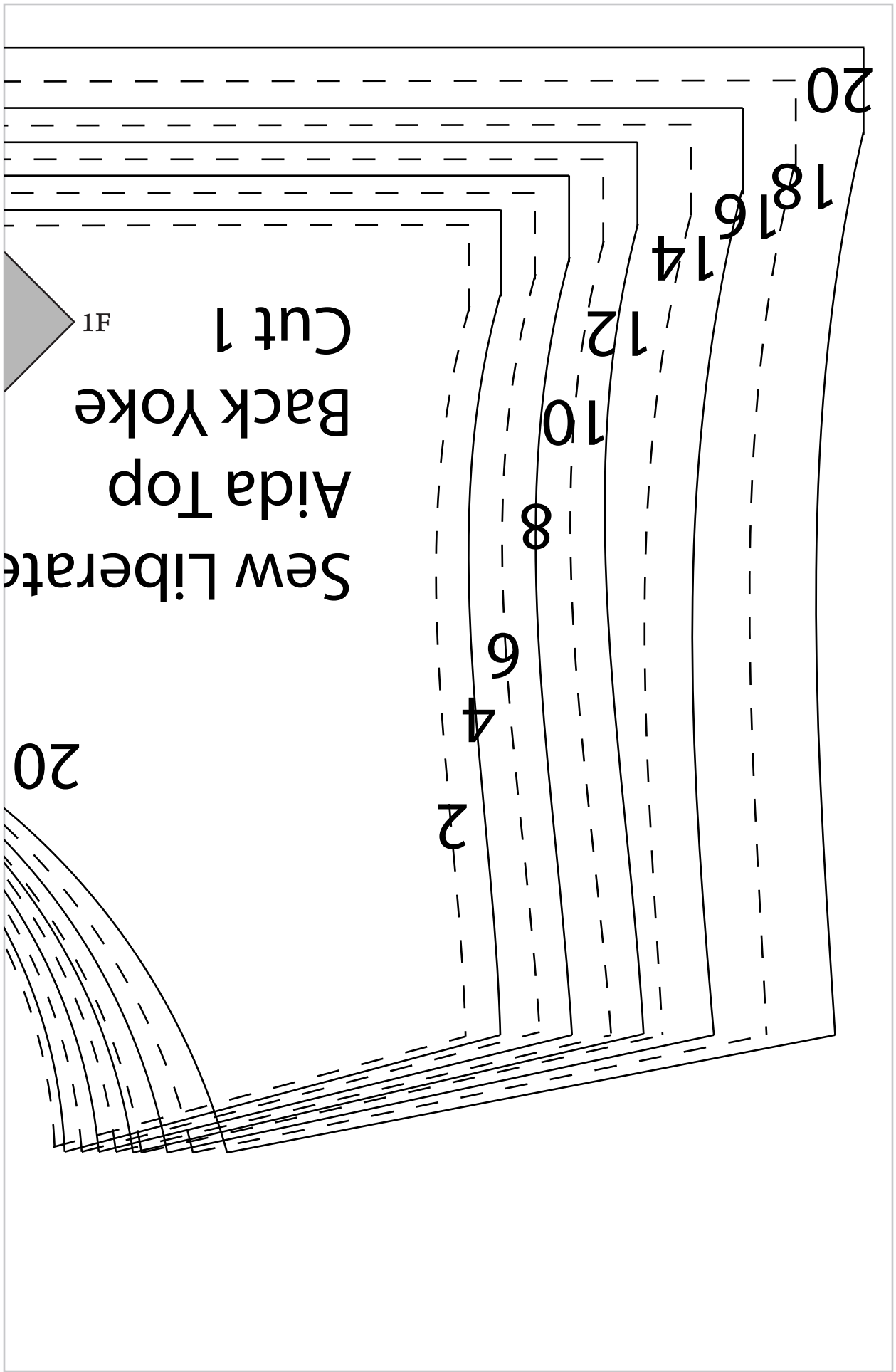



ONFOLD



4A

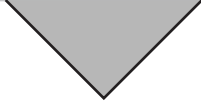

2A

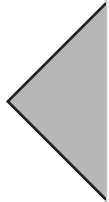

3A

Sew Liberated Aida Top Bodice Back Option B Cut 1

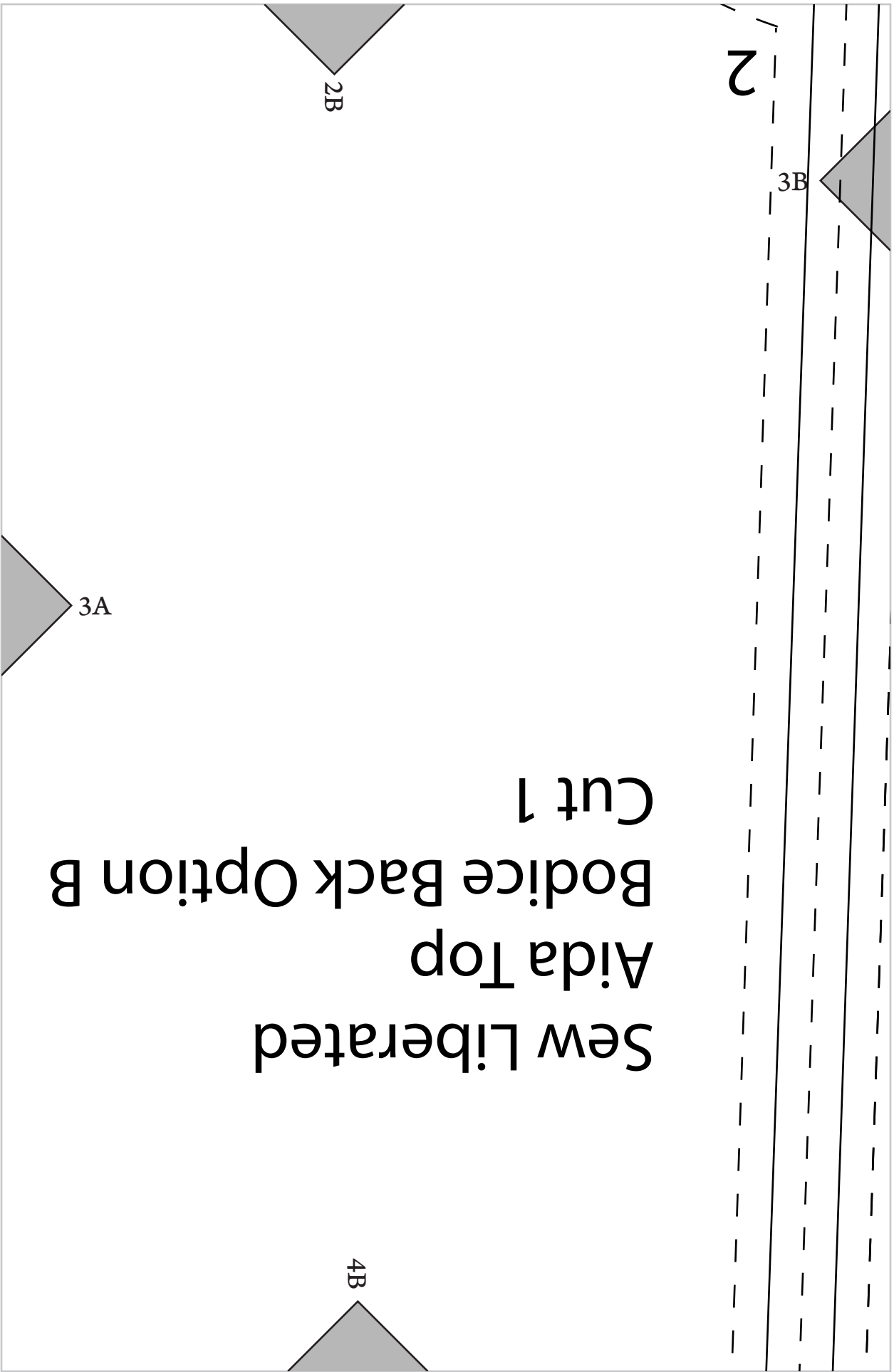

3A

2B

2

3B

4B

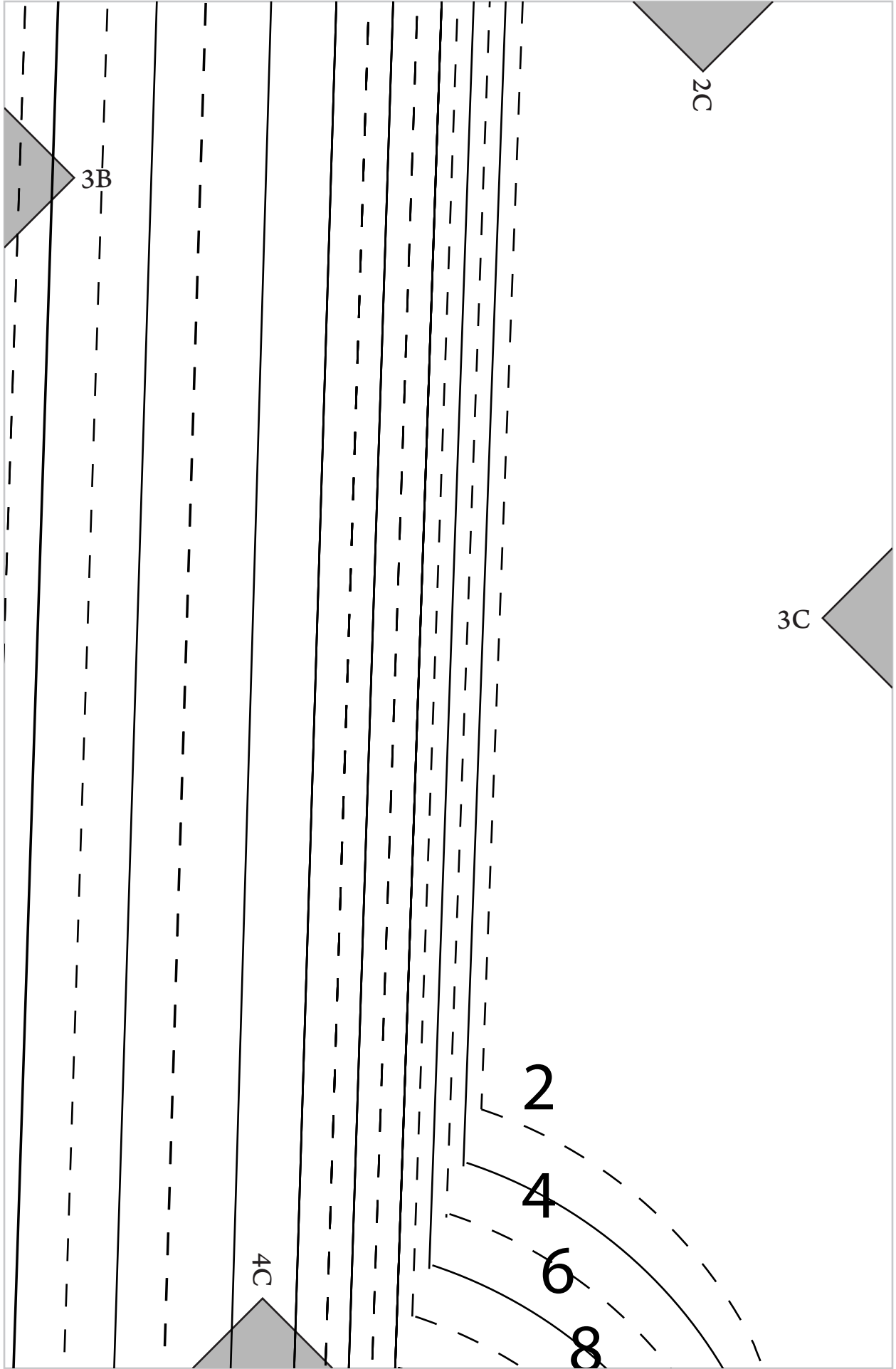

3B

2C

3C

4C

2

4

6

8

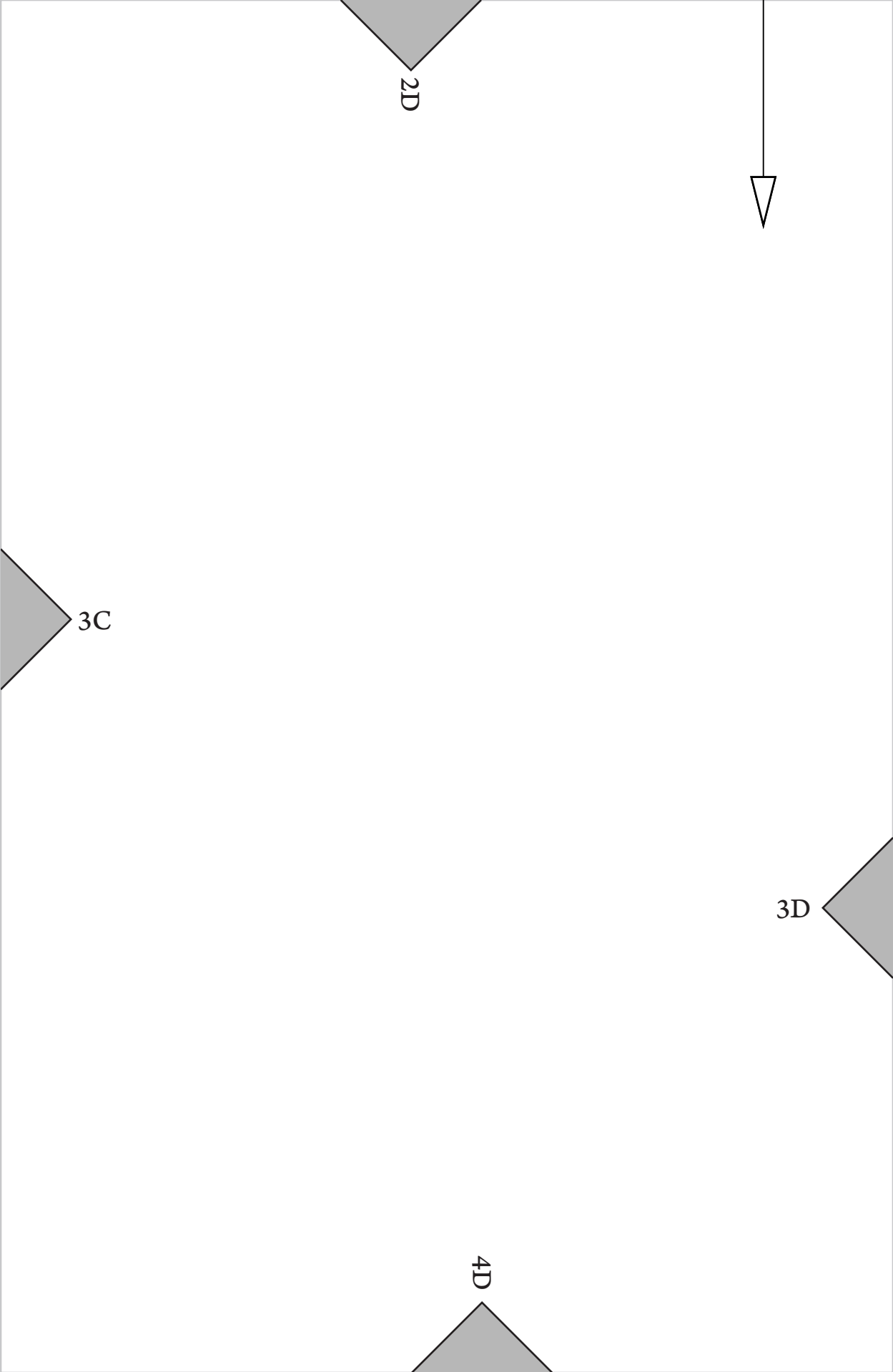

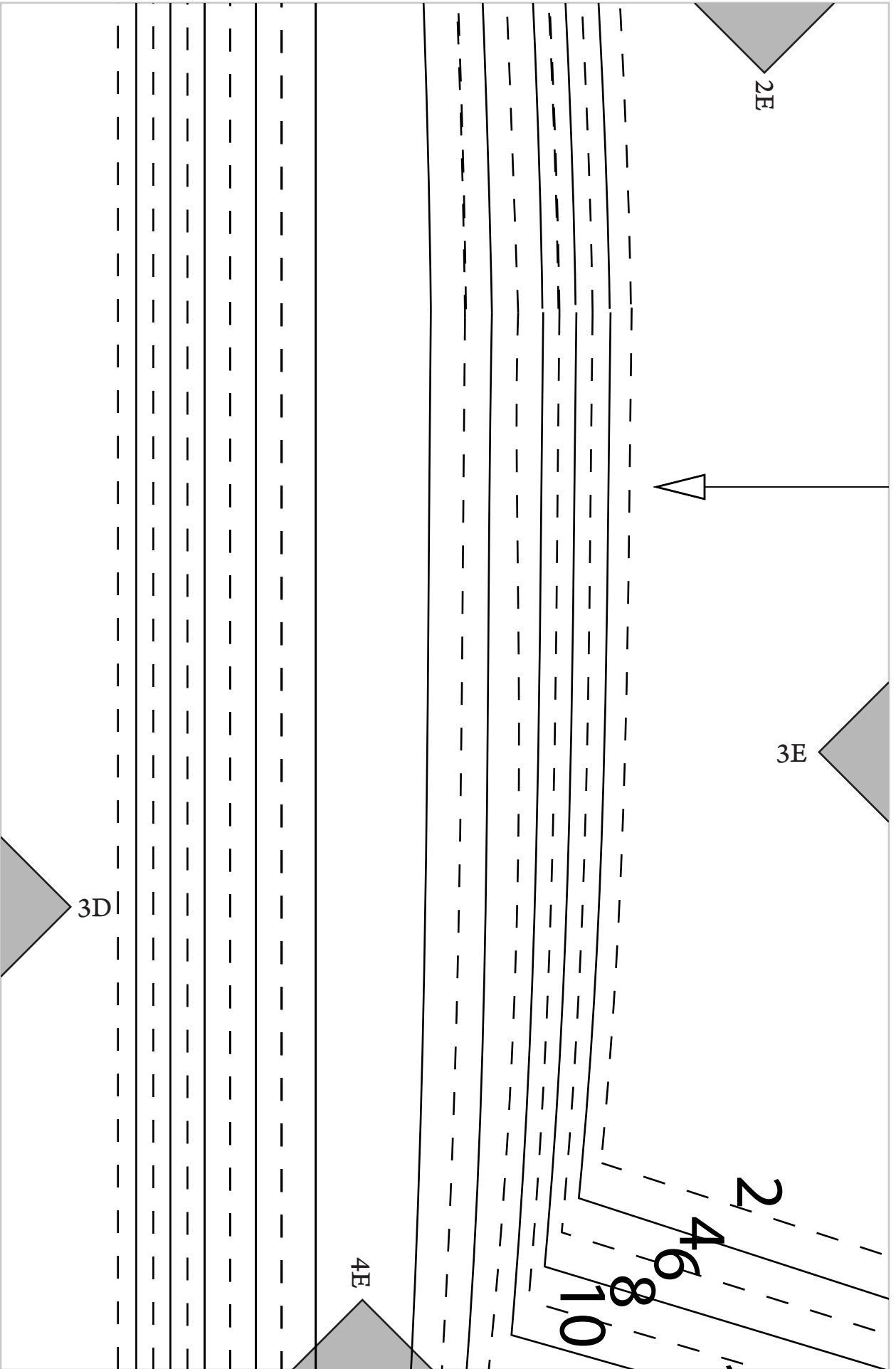

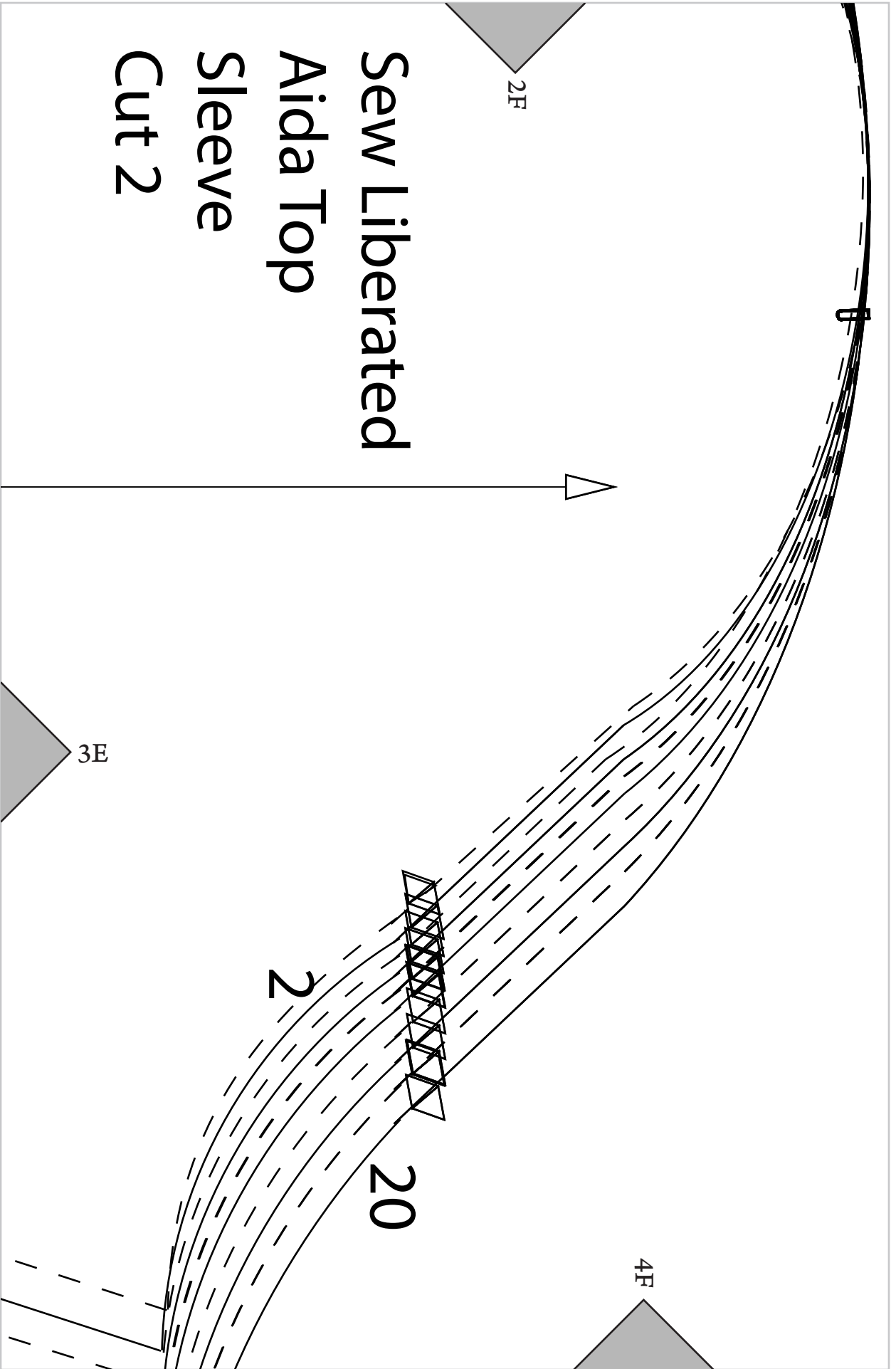

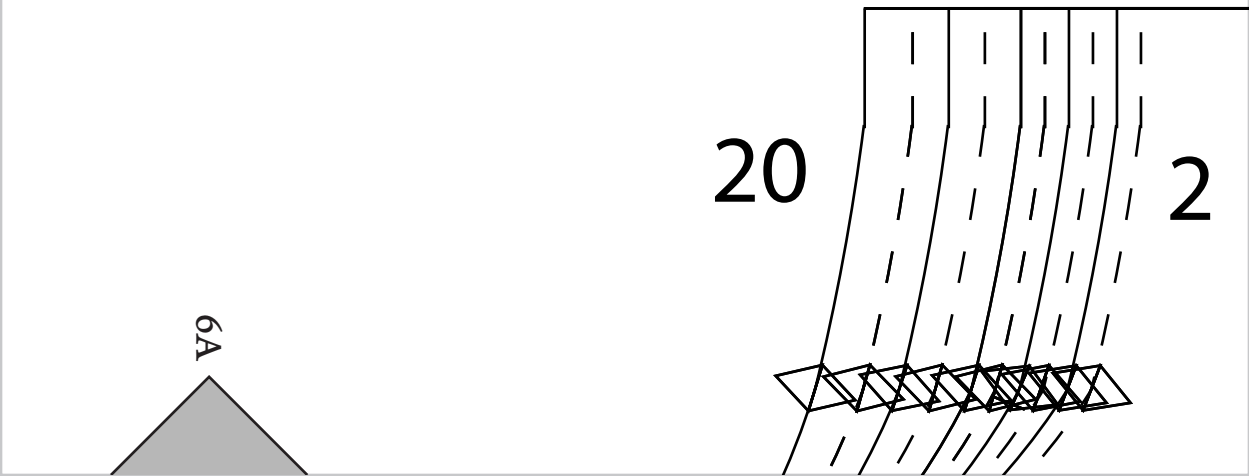
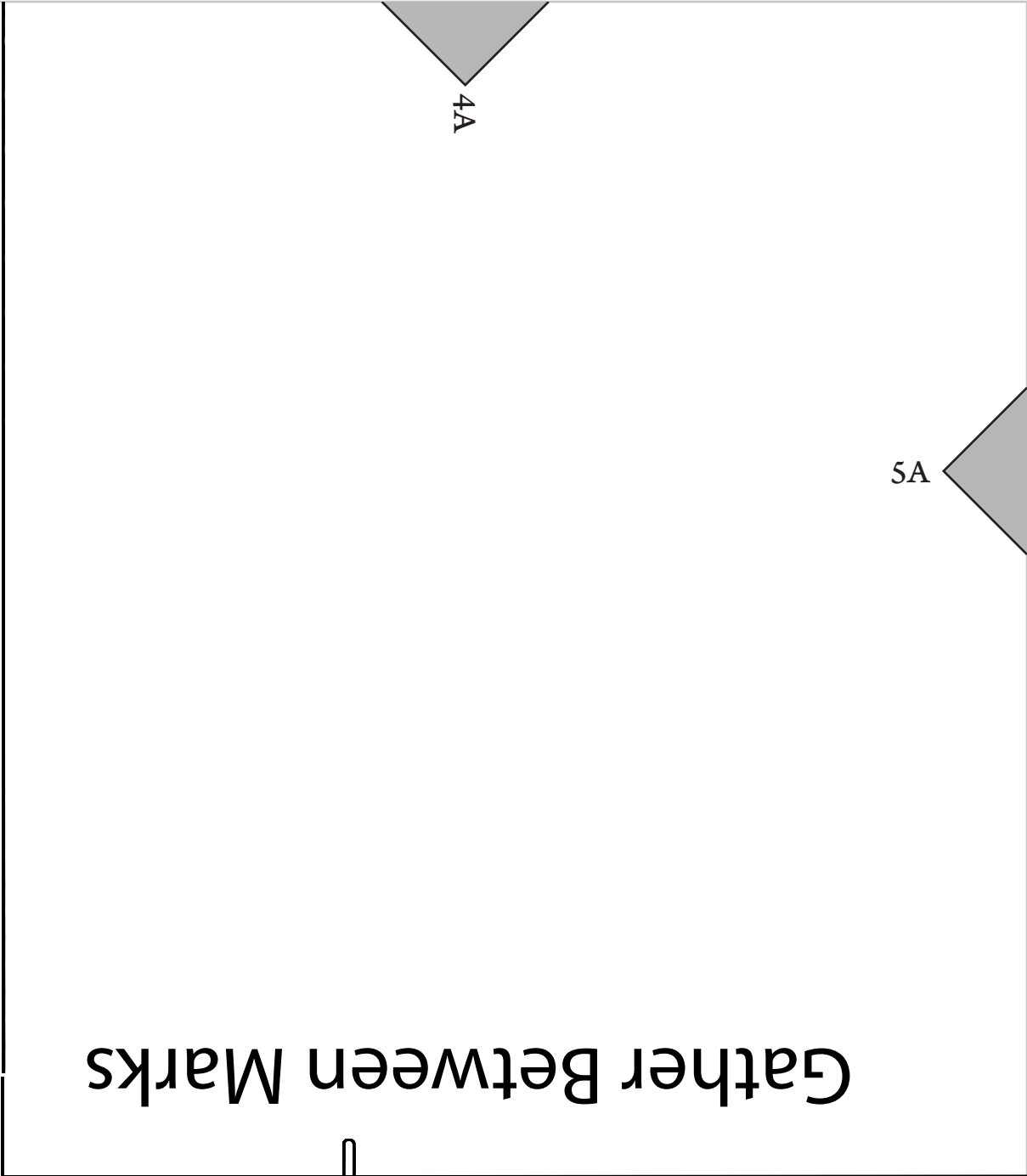

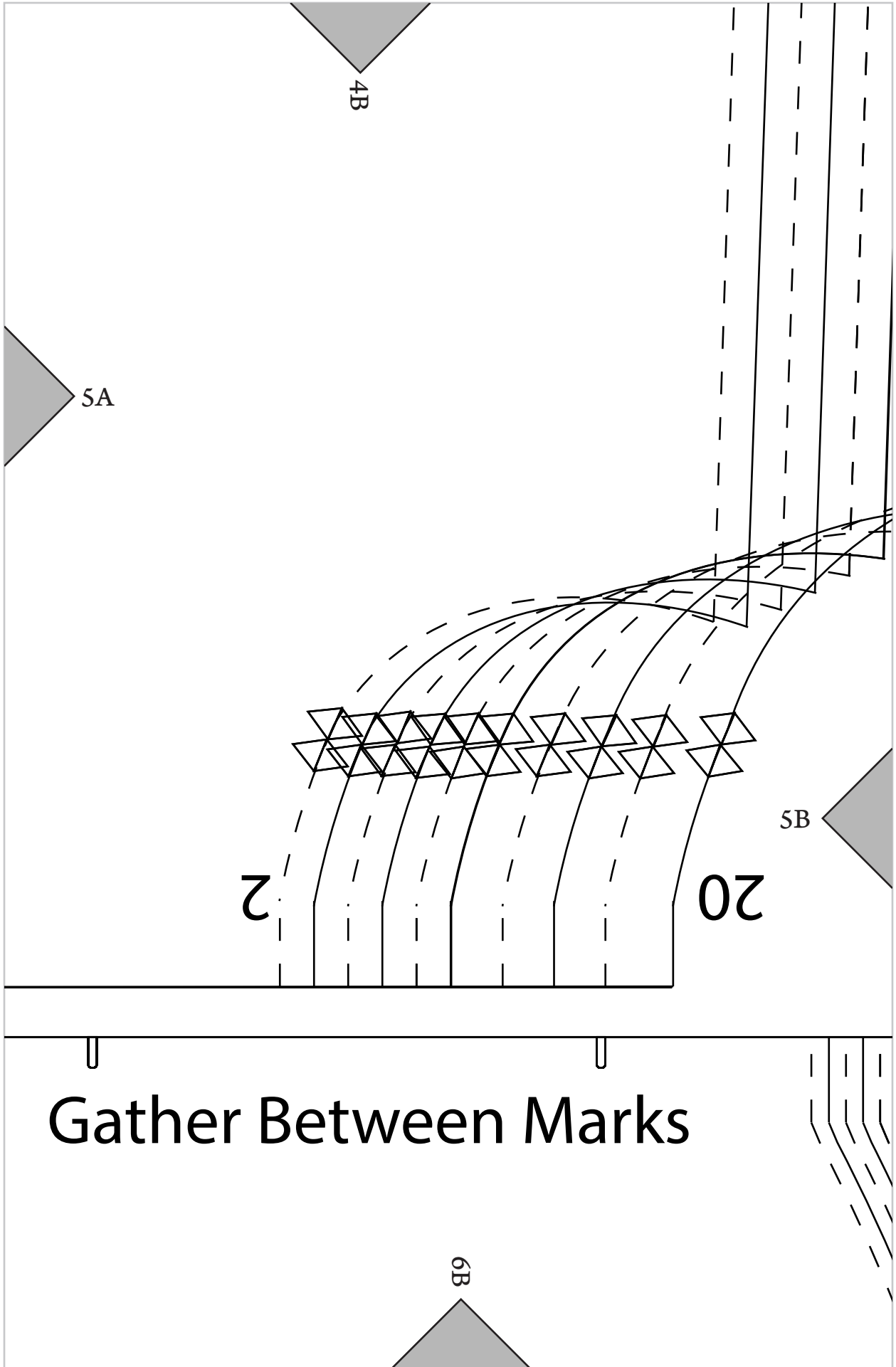

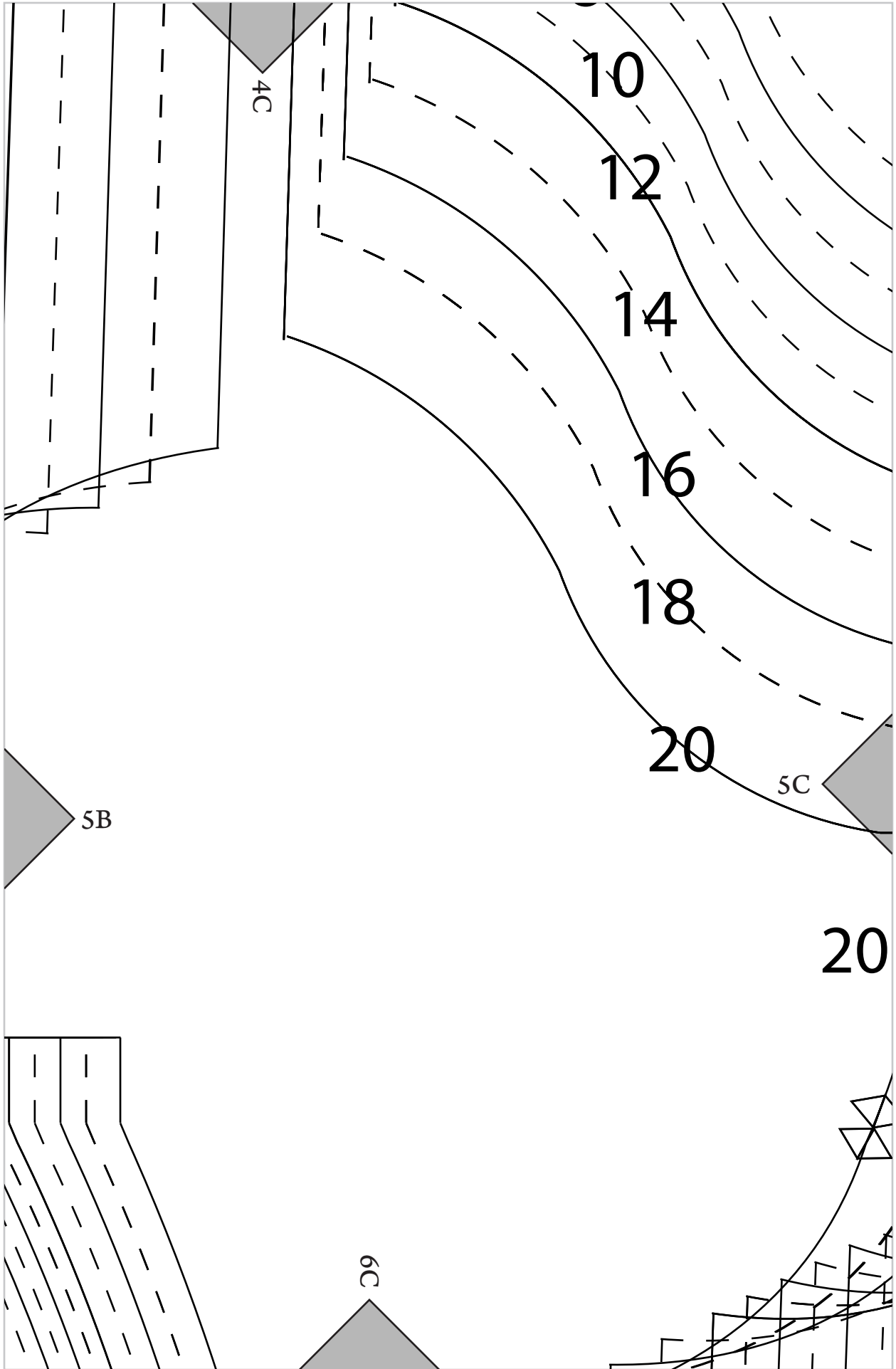

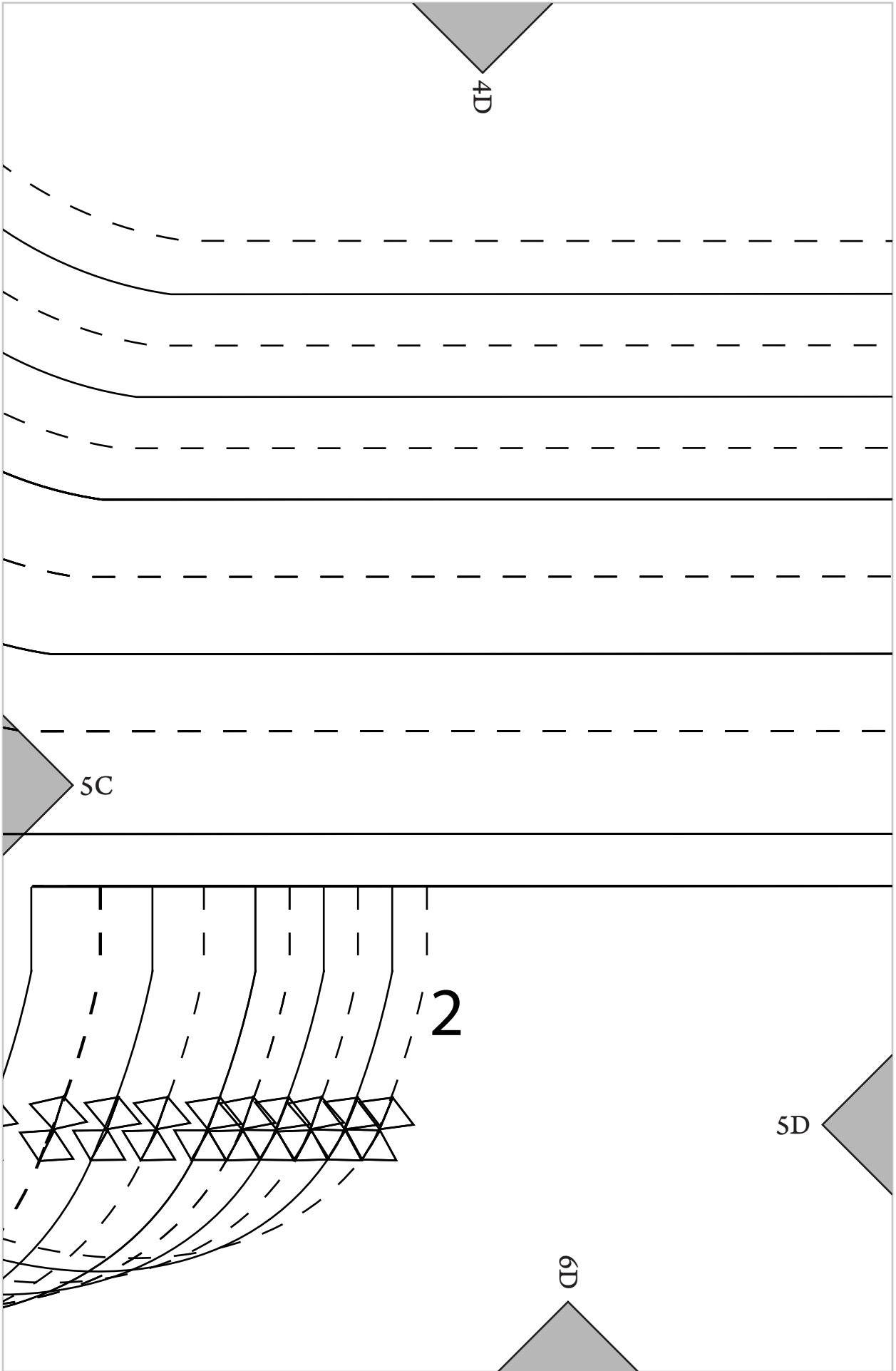

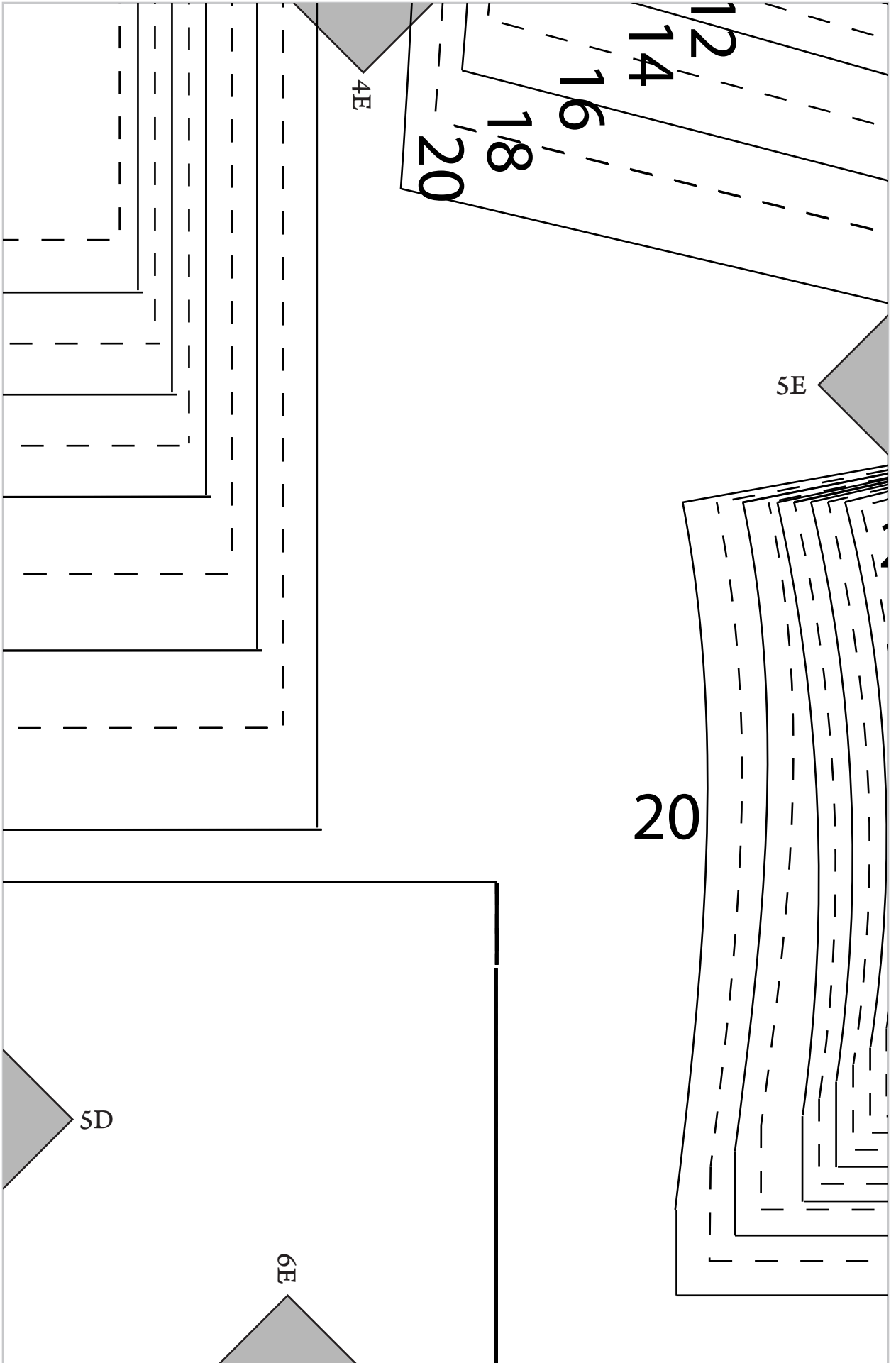

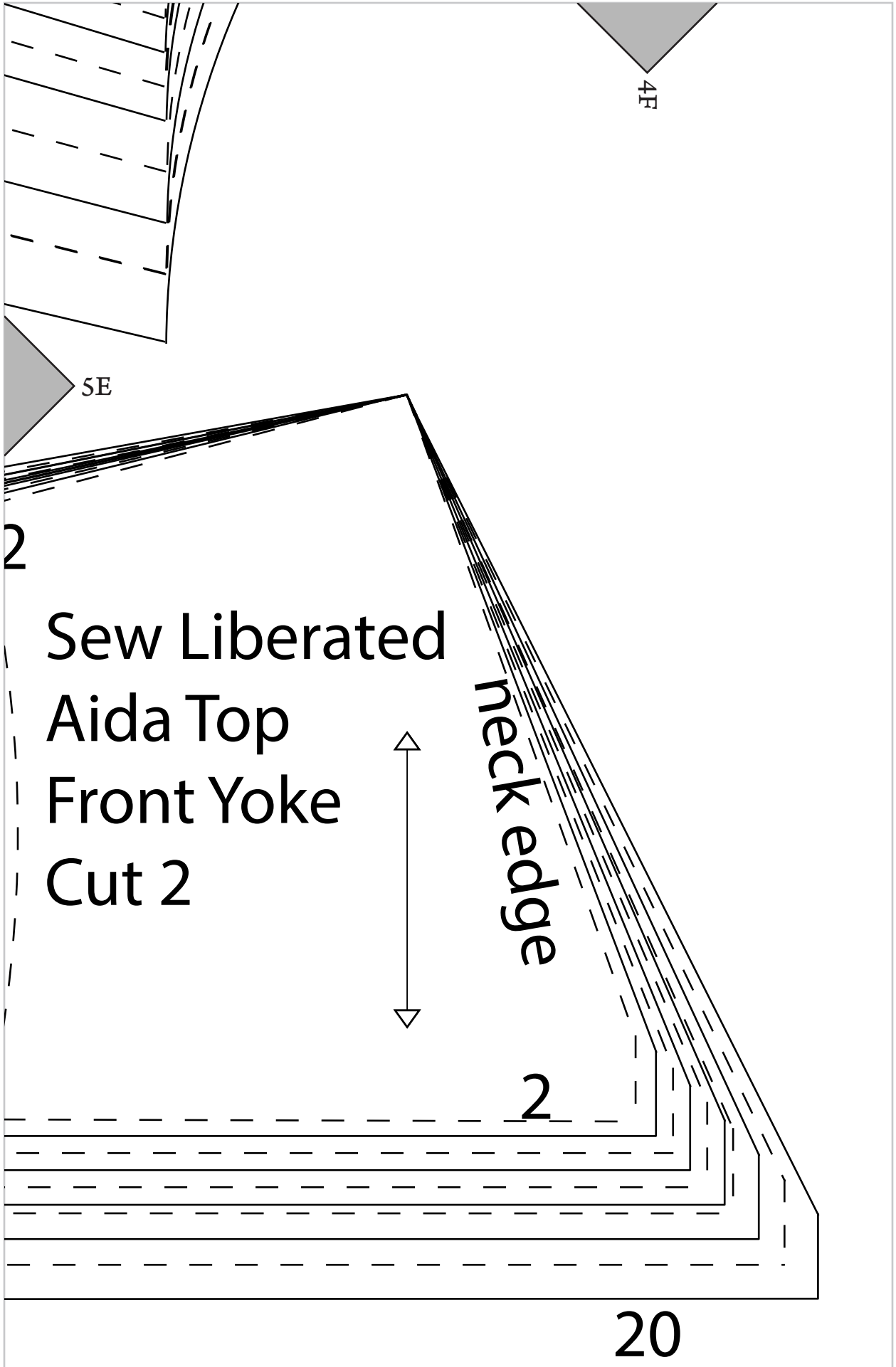

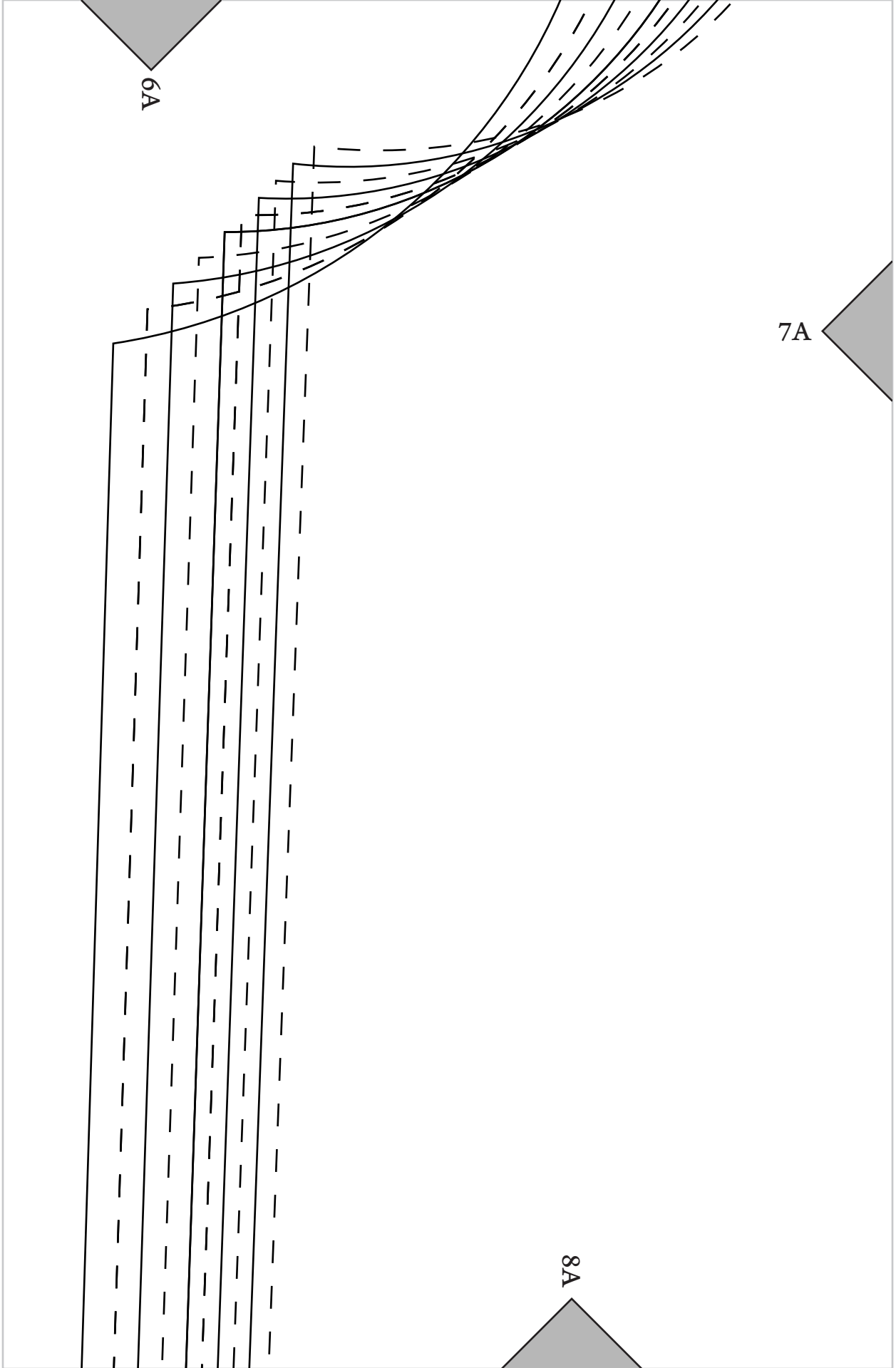

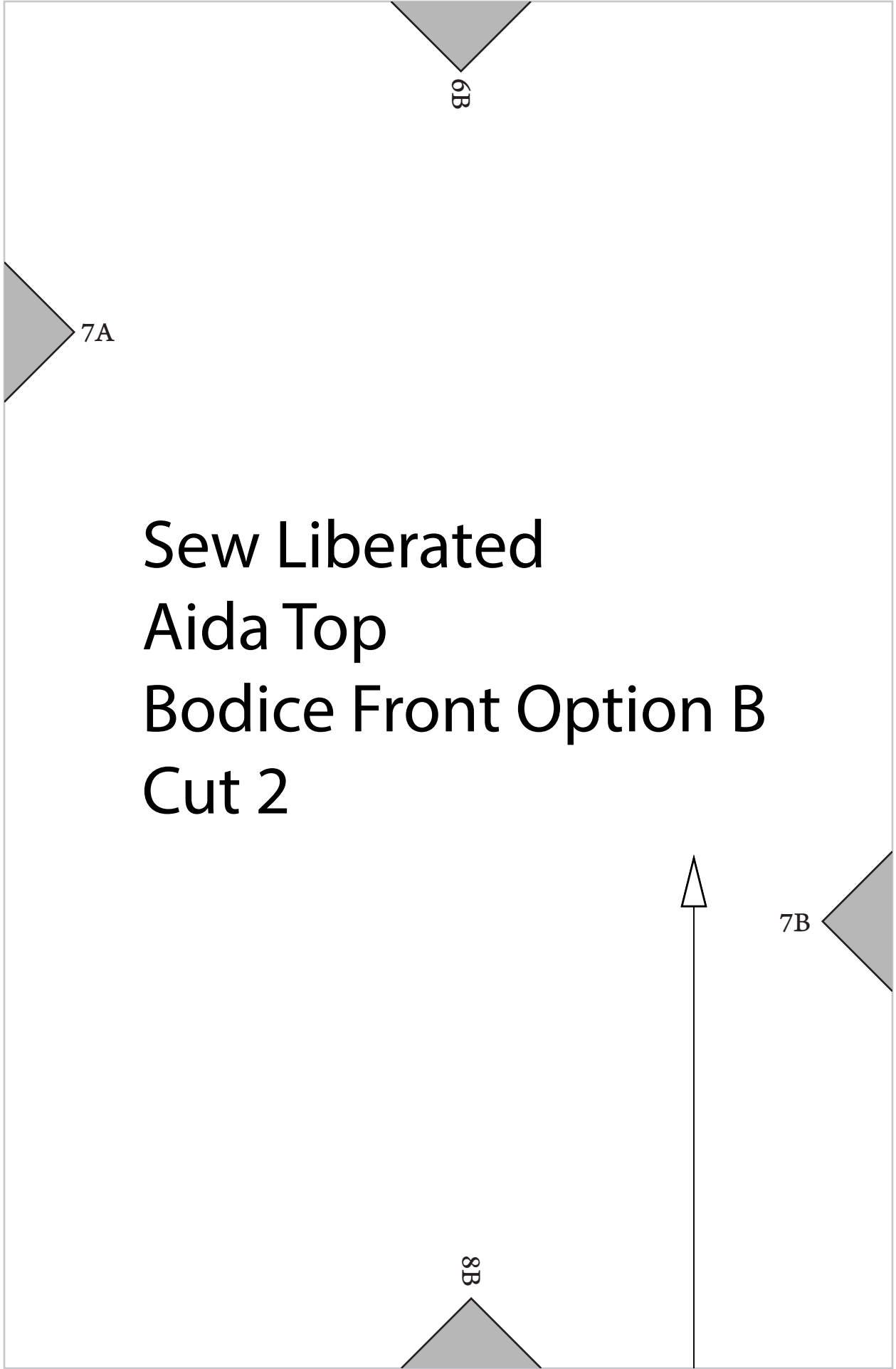

Sew Liberated Aida Top Bodice Front Option B Cut 2

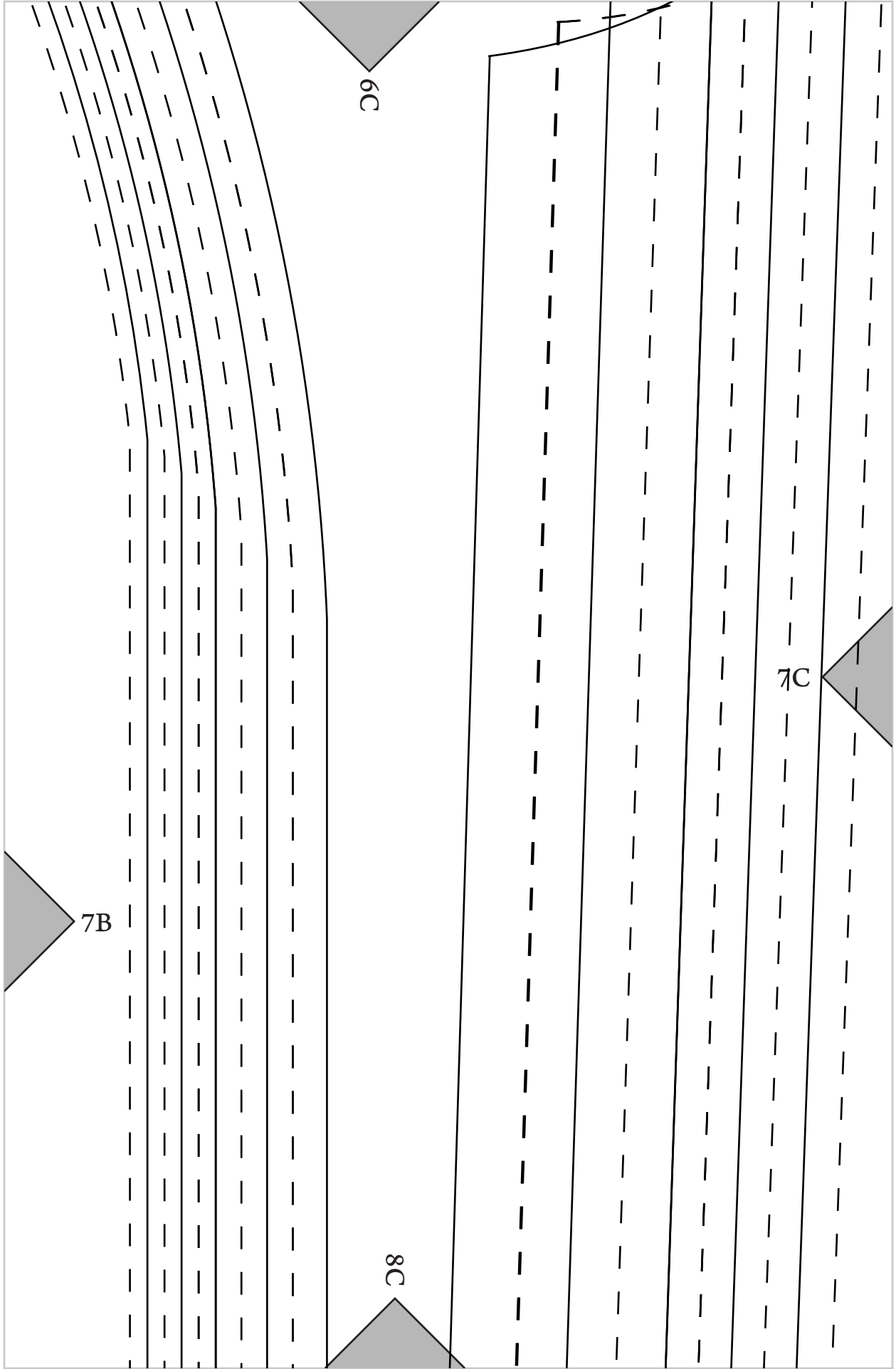

Sew Liberated Aida Top Bodice Back Option A Cut 1

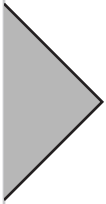

7C

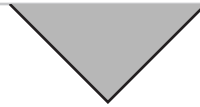

6D

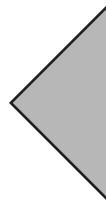

7D



8D

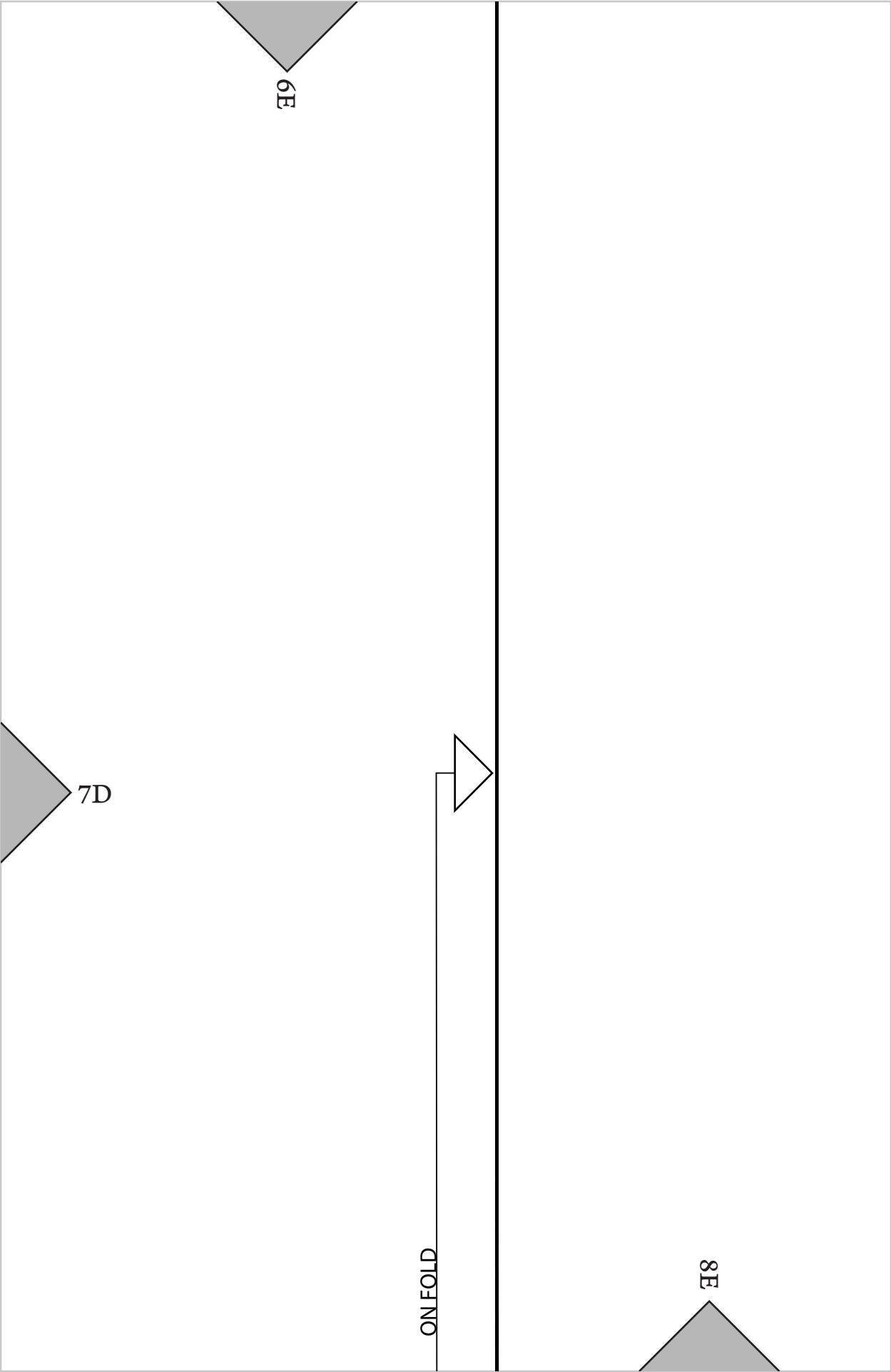

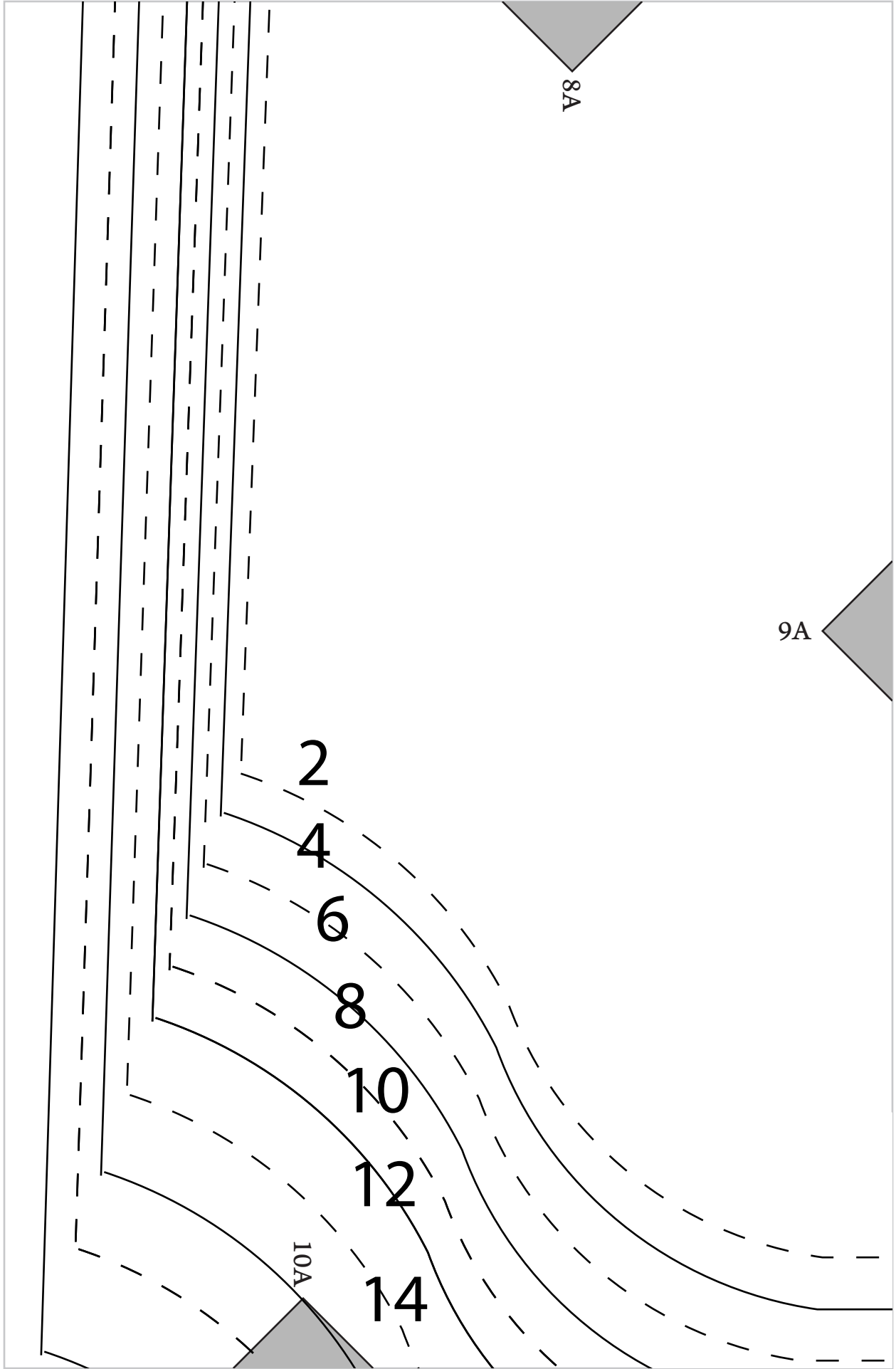

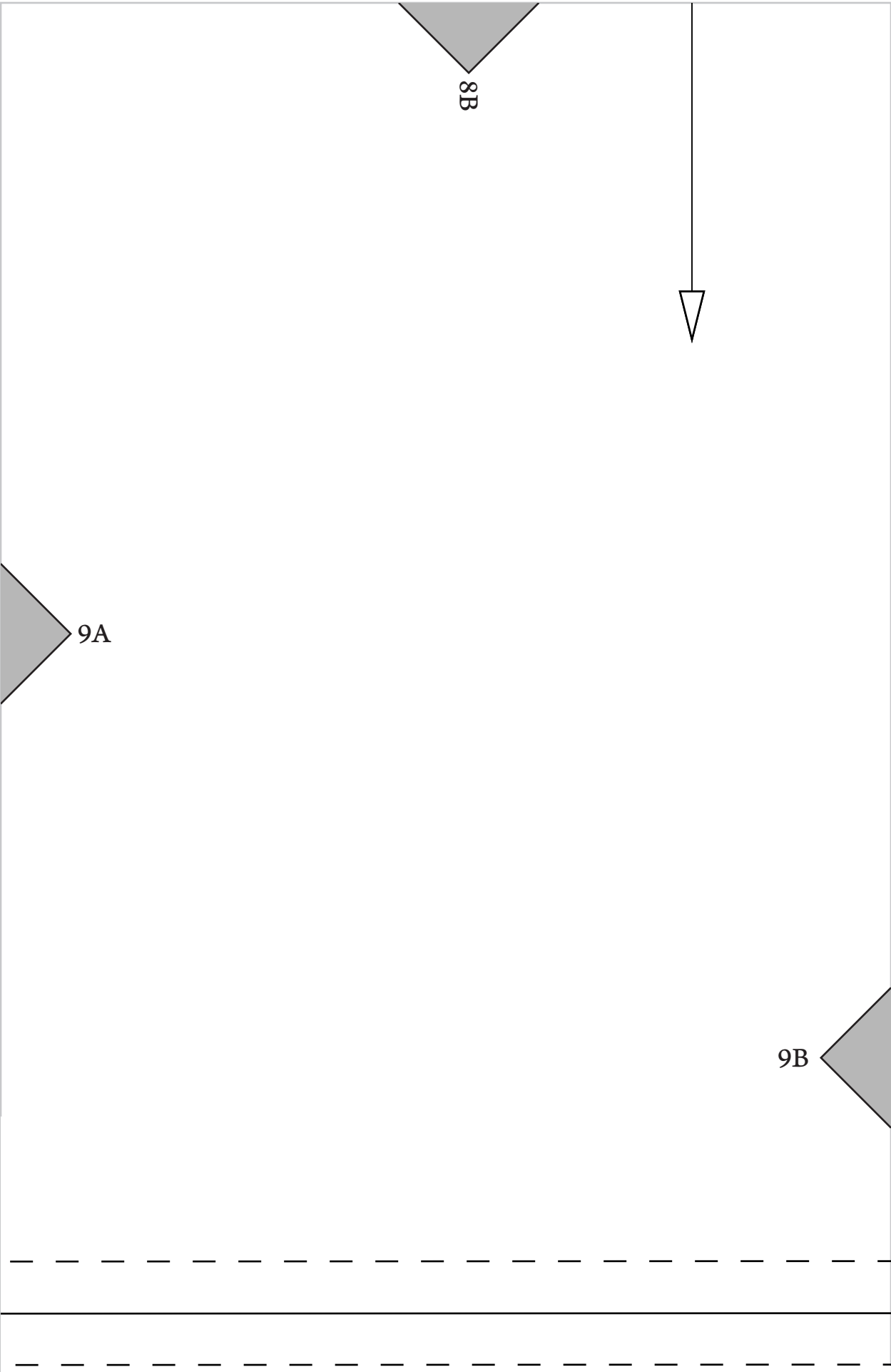

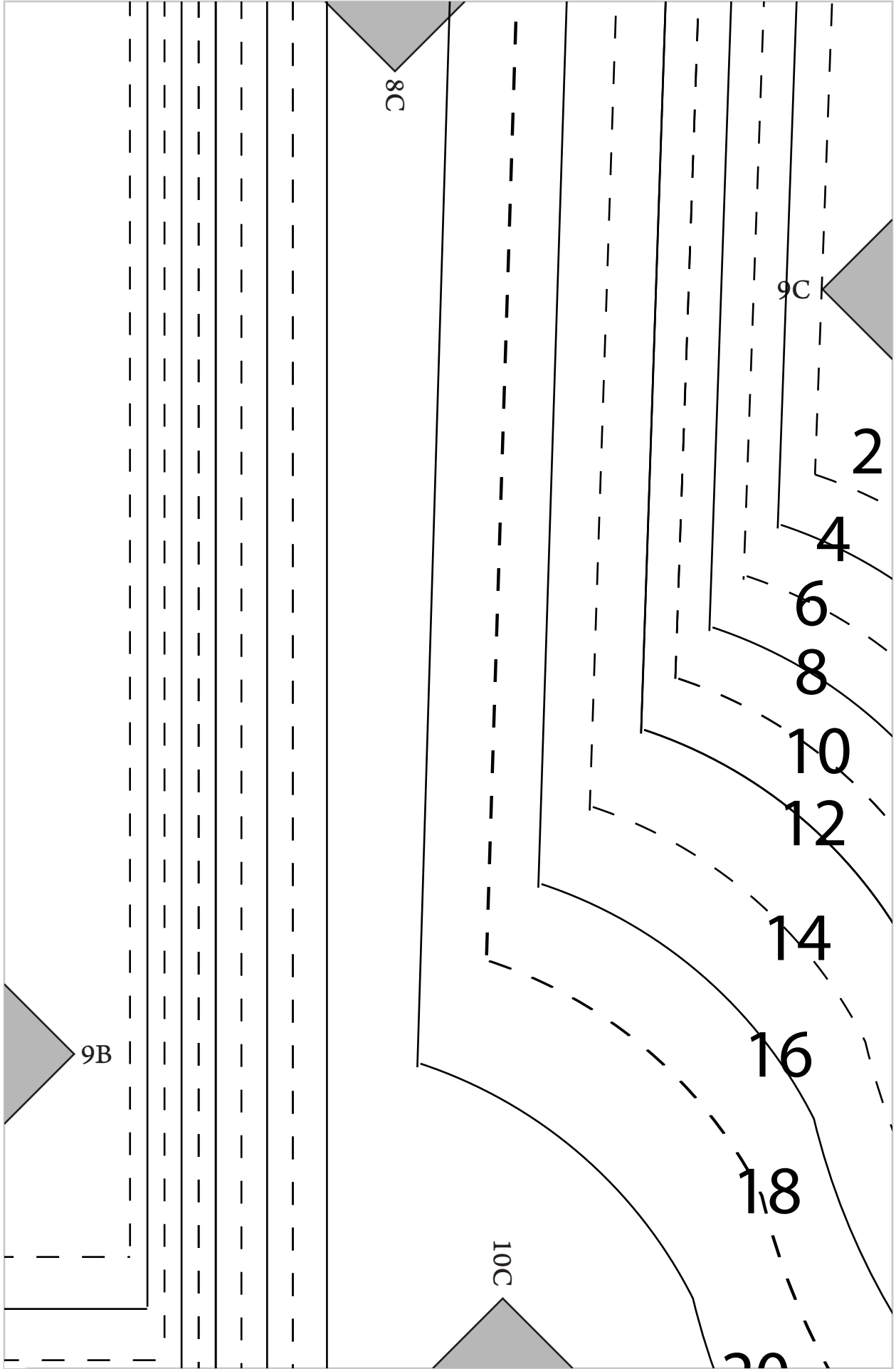

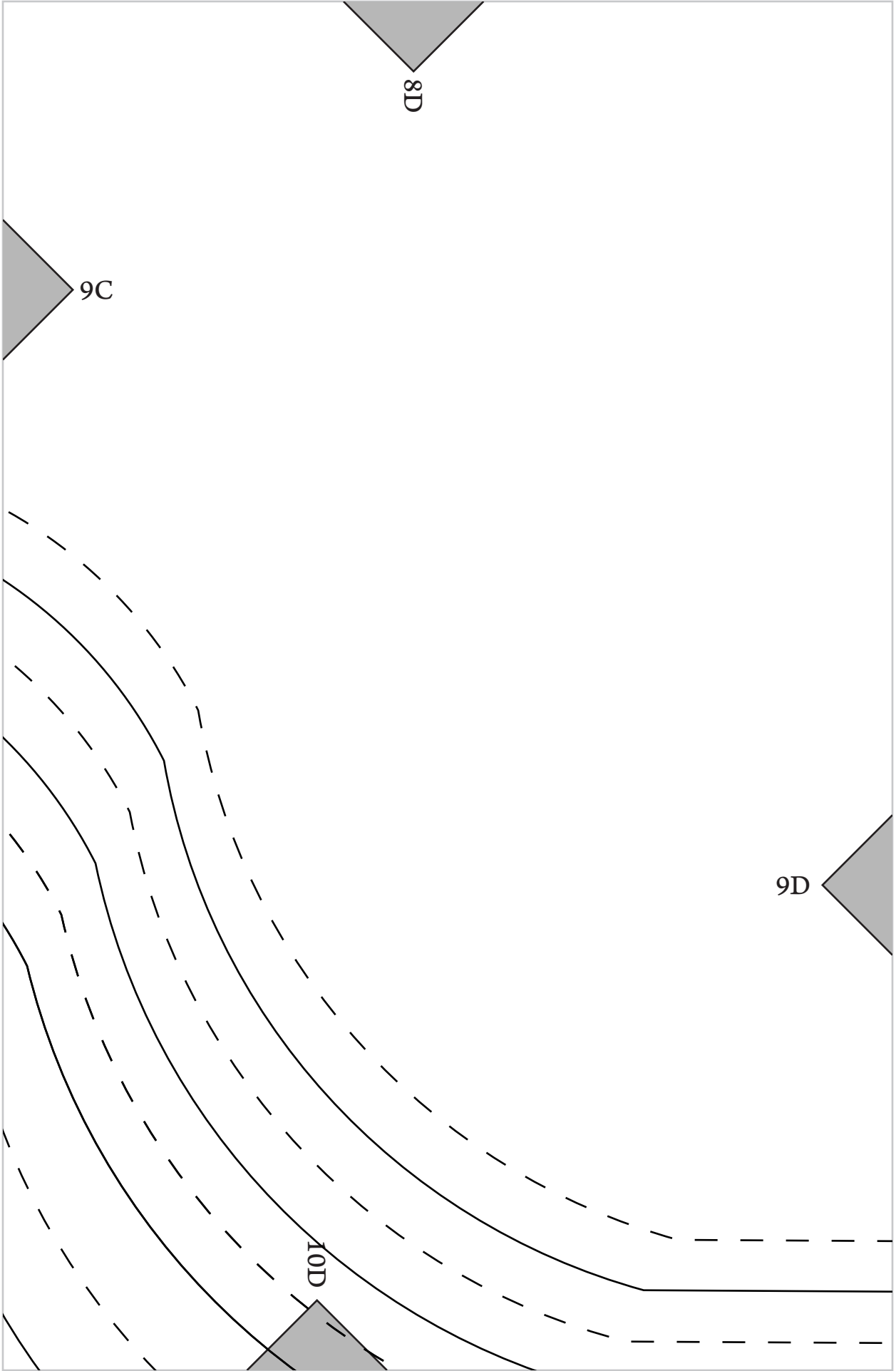

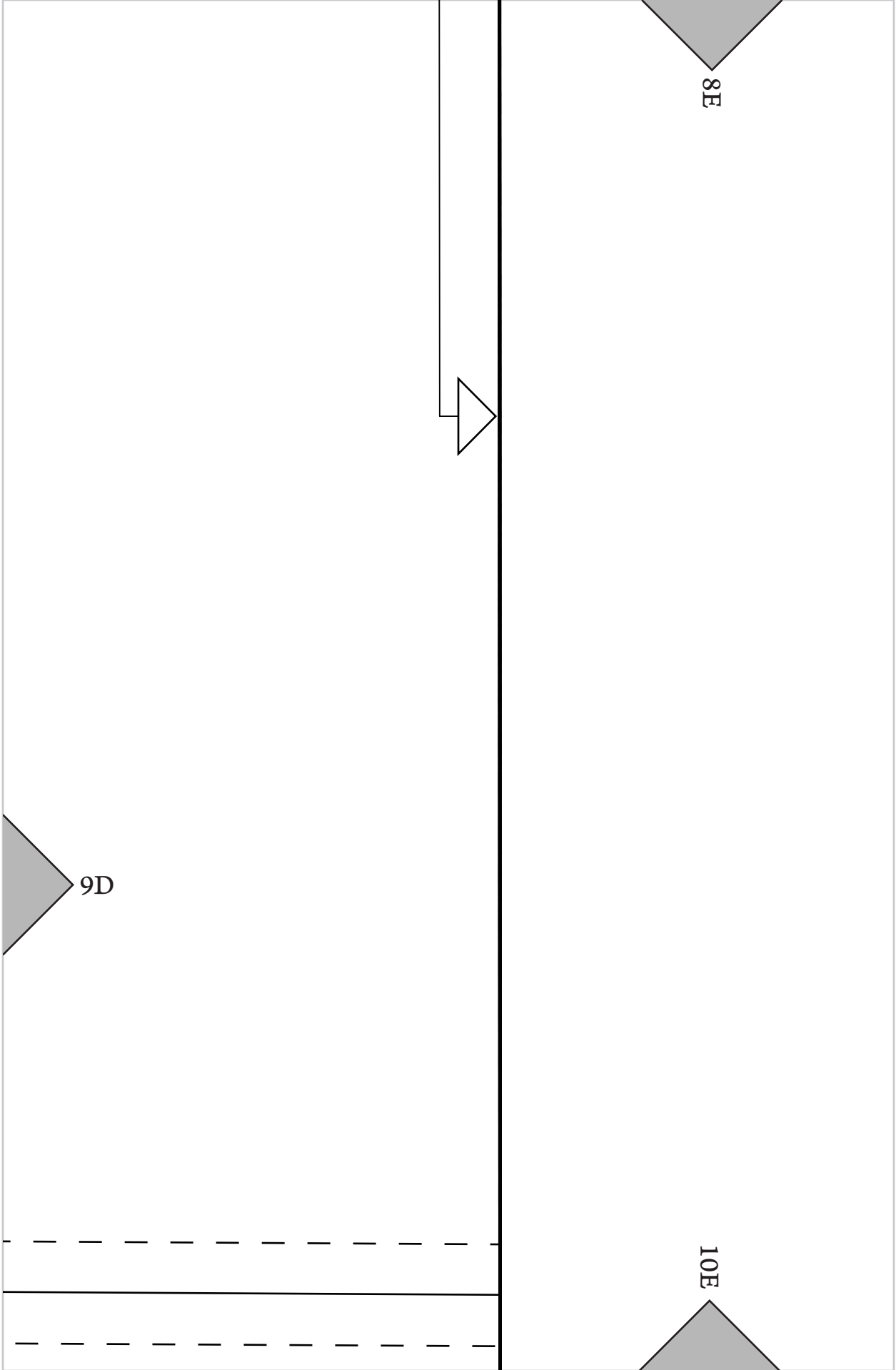

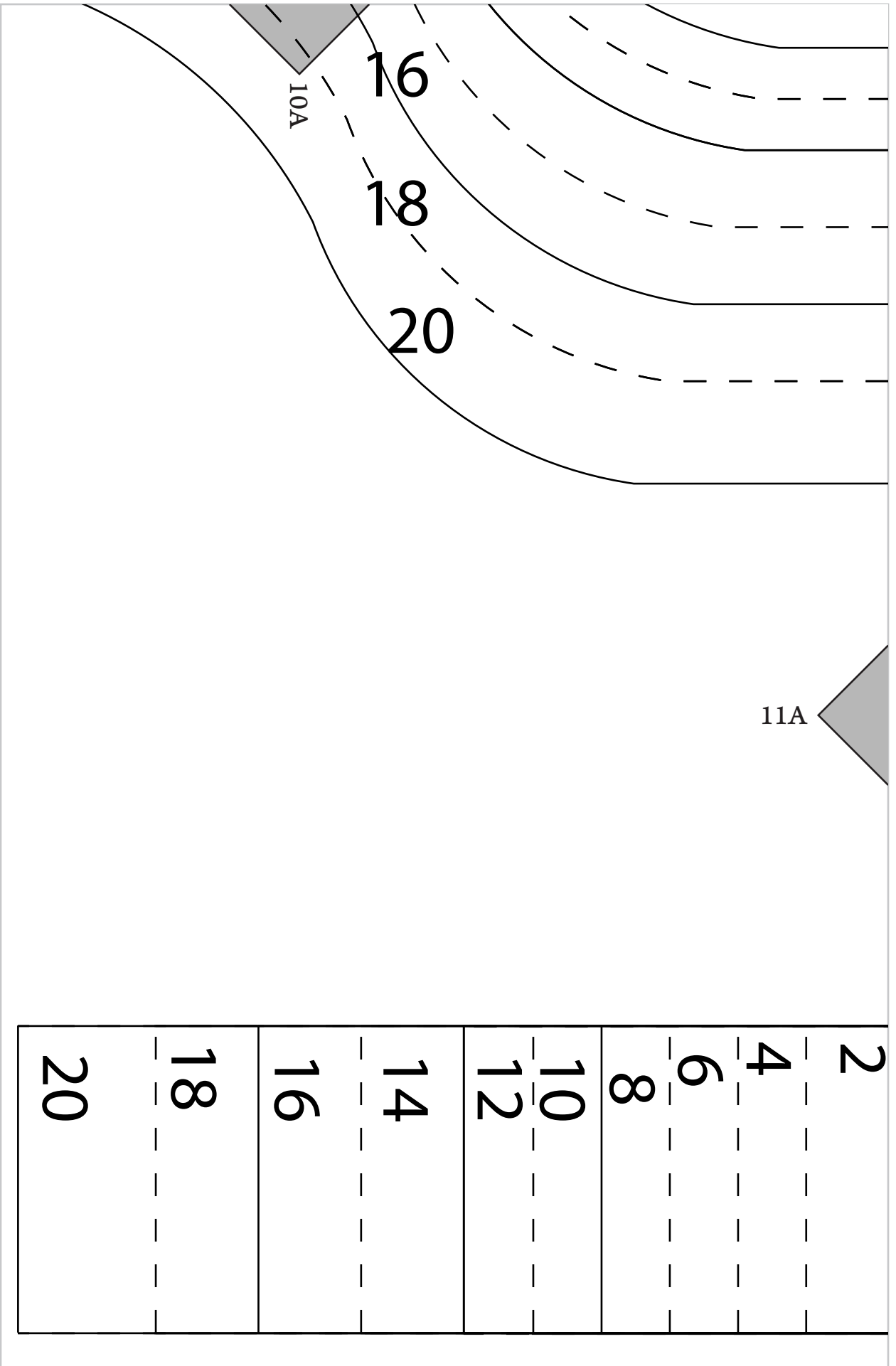

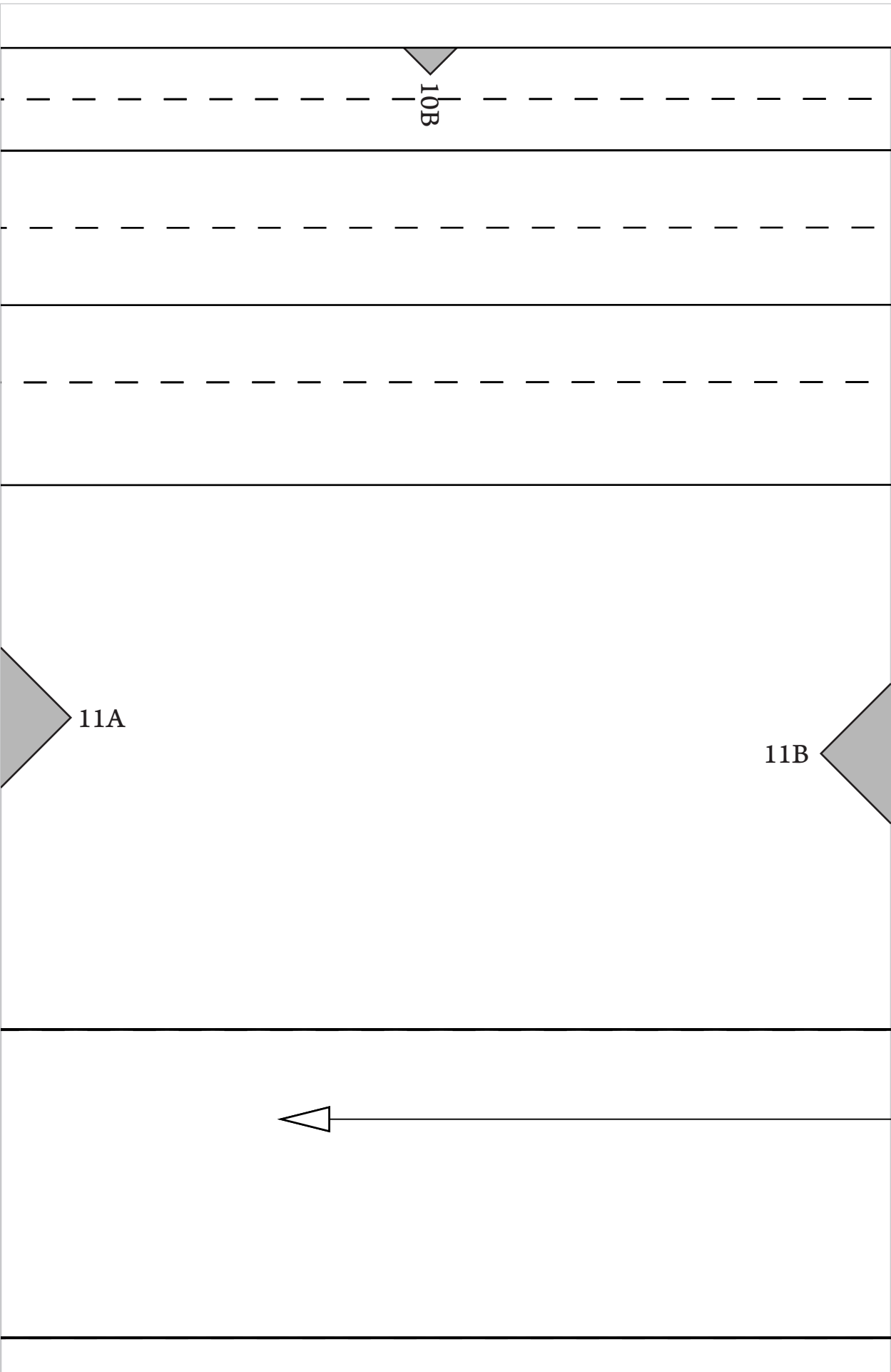

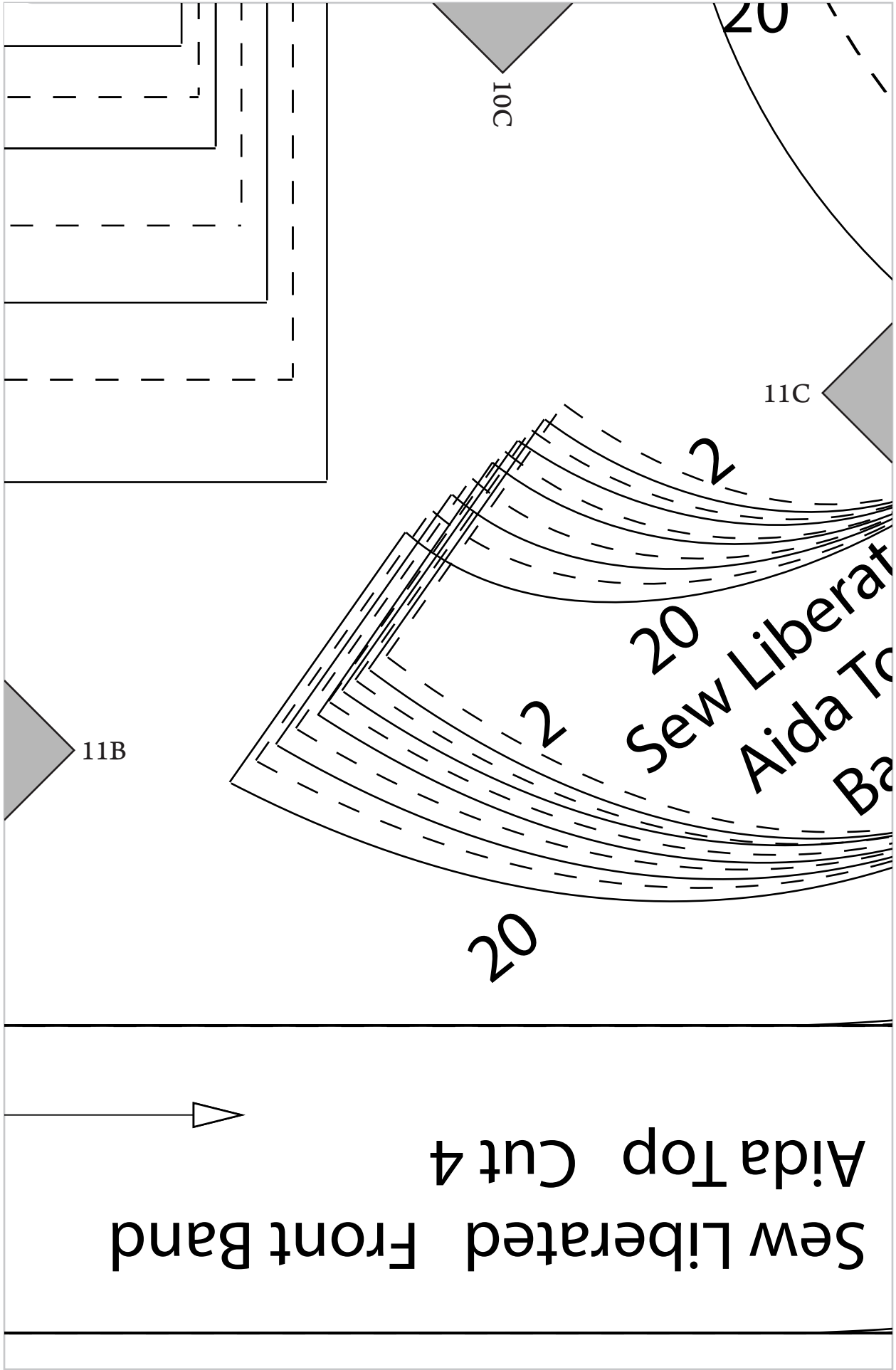

Sew Liberated Front Band
Aida Top Cut 4



